

BR-BRAKE SECTION

BR

**BRAKE
SECTION**

AA

**BRAND
OR
DESCRIPTION**

000

**PART
NUMBER**

BRAKE PAD PICTURES	Page BR-2-3-4-5-6
BRAKE PAD APPLICATION	Page BR-7-8
BRAKE DISCS	Page BR-22-23-24
BRAKE CABLES & PARTS	Page BR-27
BRAKE CARRIERS	Page BR-24-25-26
BRAKE FITTINGS	Page BR-29-30
BRAKE MECHANICAL CALIPER	Page BR-28
BRAKE PARTS ALLKART	Page BR-13
BRAKE PARTS AZZURRO	Page BR-13
BRAKE PARTS DAP	Page BR-13
BRAKE PARTS DENT	Page BR-14-15-16-17
BRAKE PARTS CRG	Page BR-18
BRAKE PARTS KSI [ITALSPORT]	Page BR-18
BRAKE PARTS MAC MINARELLI	Page BR-18
BRAKE PARTS MONACO	Page BR-19
BRAKE PARTS MIKE WILSON	Page BR-19
BRAKE PARTS PCR	Page BR-19
BRAKE PARTS RIGDETTI RIDOLFI	Page BR-20-21
BRAKE PARTS SWISS HUTLESS	Page BR-20
BRAKE PARTS TONY	Page BR-20
BRAKE SCHEMATICS GENERAL	Page BR-10
BRAKE SCHEMATICS CRG	Page BR-11
BRAKE SHIMS	Page BR-7

BRAKE PADS

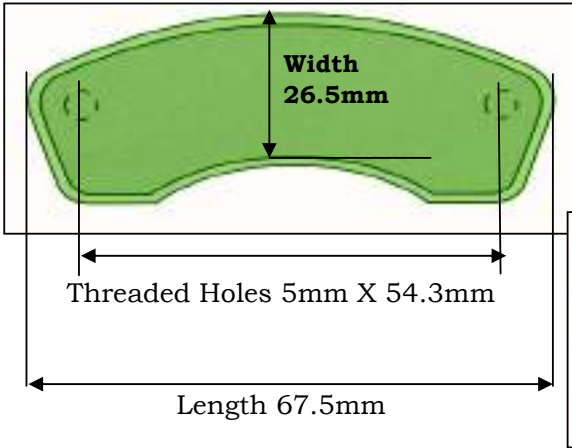

TONY KART FRONT PADS
7mm THICK

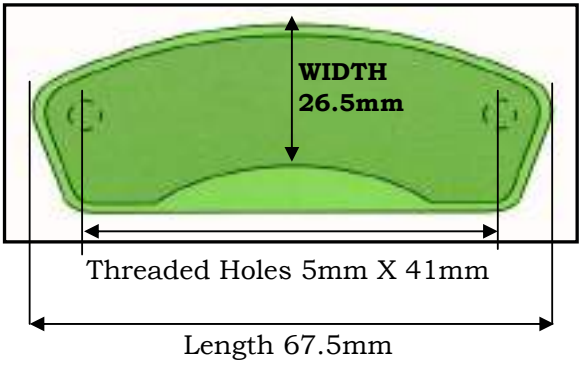
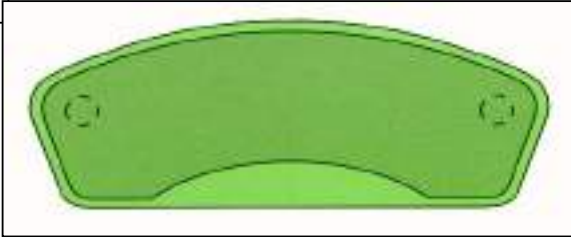

ALLKART FRONT PADS
7mm THICK

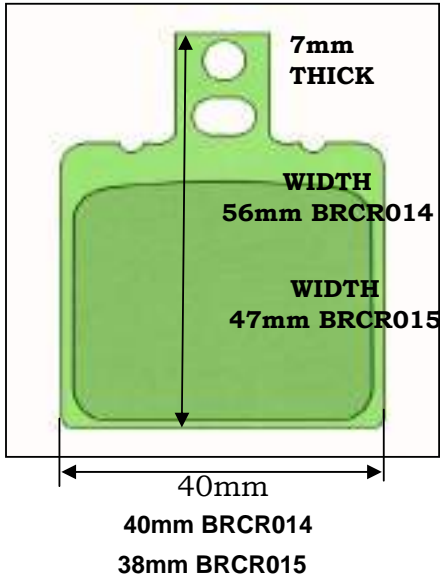

REAR BRAKE PADS
LATE CRG
TWIN CALIPER/SMALL DISC
4 PADS PER KART
BREMBO 222
FD7266

BRAKE PAD SCHEMATICS

BRDE004A
[11mm thick]
SOFT ARROW

BRDE004B
[11mm thick]
HARD ARROW

BRDE004AN
[11mm thick]
NEWFREN Med



BRDE004C
[15mm thick]
HARD ARROW

BRDE004NR
[15mm thick]
NEWFREN Med

Brake Pad DENT/ARROW Brakes Hydraulic & Mechanical

BRDI001A
HARD



Brake Pad DINO Brakes Hydraulic & Mechanical

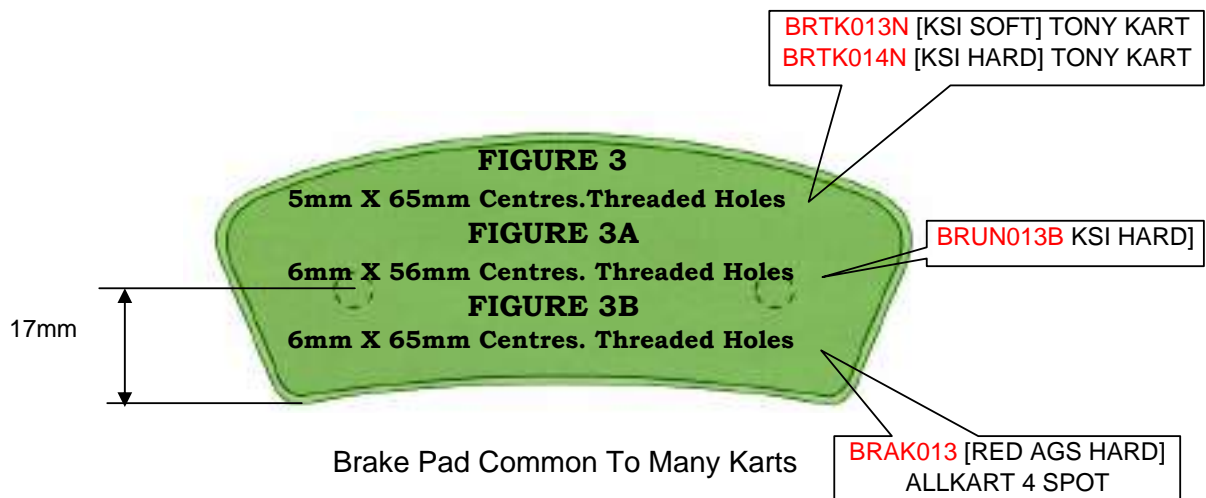

Brake Pad Common To Many Karts

BRAKE PADS

FIGURE 4A
SWISS HUTLESS [LONG] & UNIVERSAL

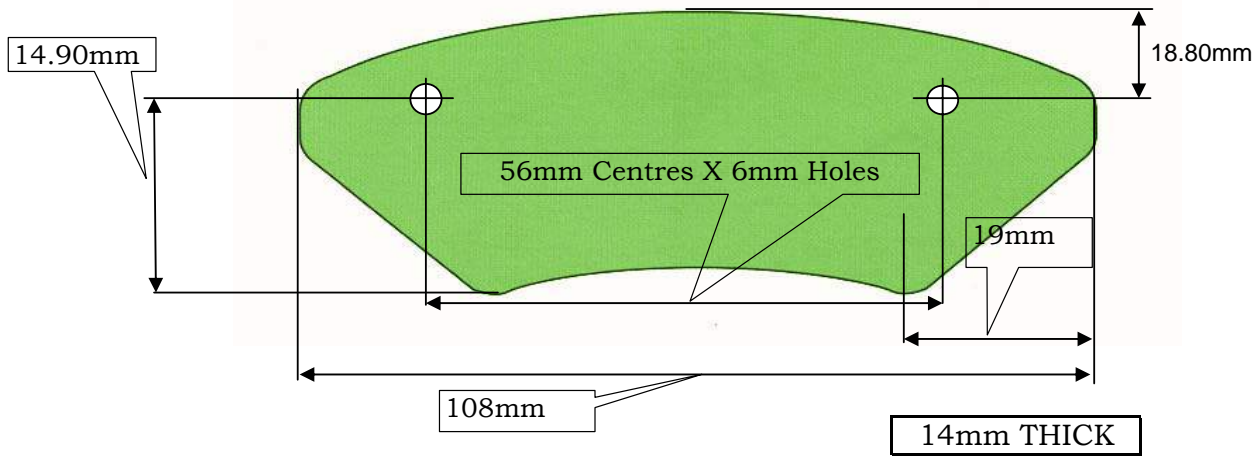

BRUN013E

[GPT]

SWISS HUTLESS

FIGURE 4

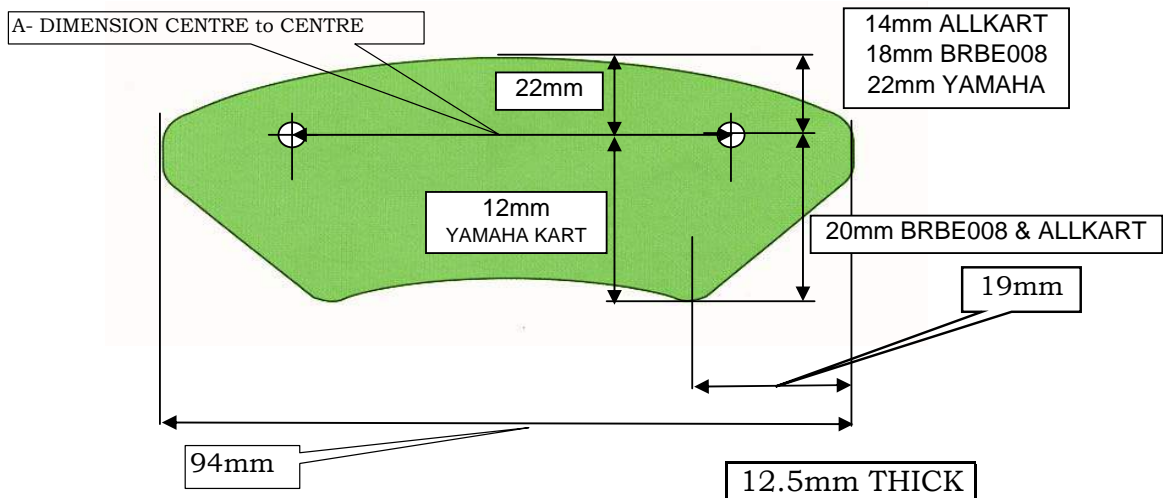

UNIVERSAL BRAKE PADS FITS MANY BRANDS OF KARTS

BRUN002

60mm Centre to Centre X 6mm

YAMAHA KART

MEDIUM COMPOUND

BRAK001N

56mm Centre to Centre X 6mm

ALLKART , AZZURRO , DAP

MED COMPOUND

S/HUTLESS , UNIVERSAL

BRUN013C

55mm Centre to Centre X 6mm

[RED AGS BRAND] MEDIUM COMPOUND

BRBE008

56mm Centre to Centre X 6mm 13mm THICK

BRAKE PAD SCHEMATICS

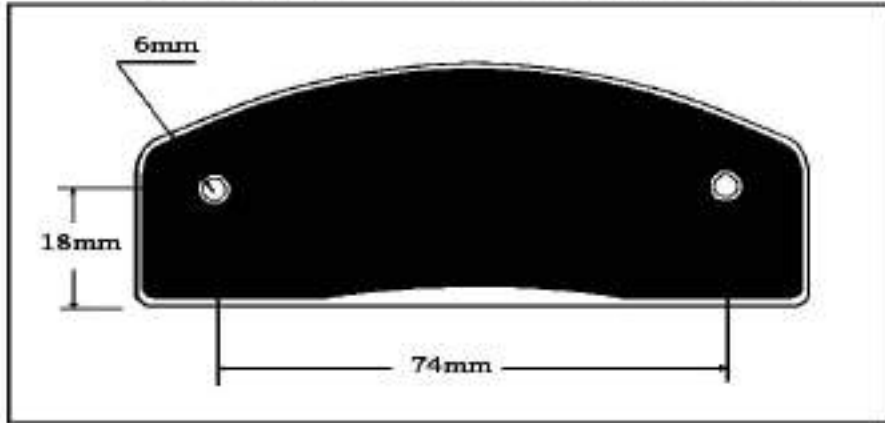

Figure 5 [56mm Centres 6mm Threaded Holes] 17mm Thick
 Figure 5A [65mm Centres 6mm Threaded Holes] 17mm Thick
 Figure 5B [74mm Centres 6mm Threaded Holes] 17mm Thick

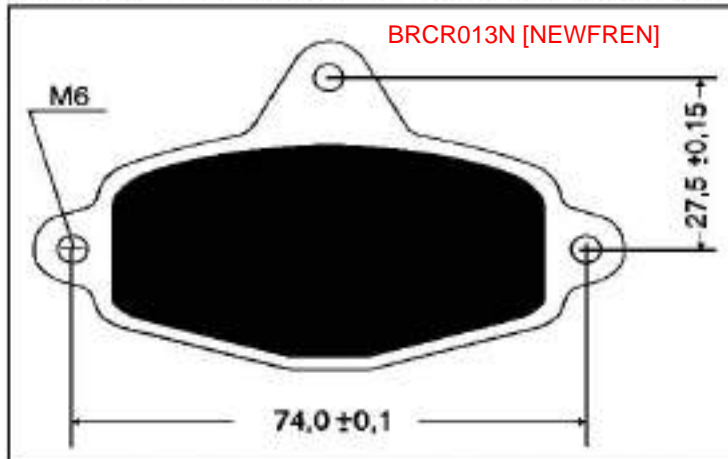

Figure 6 [74 mm Centres 6mm Threaded Holes] 14mm Thick



Figure 7 [No Threaded Mounting Holes] 14.5 Thick

The REDAGS pads have 6mm threaded mounting holes

Note

DAP KART ORIGINAL MECHANICAL & HYDRAULIC BRAKES

- | | |
|----------|--------------------|
| BRUN013A | [BENSON OK] |
| BRUN013B | [KSI OK] |
| BRTK001 | [KSI OK] FIGURE 5 |
| BRUN013C | [RED] WILL NOT FIT |

BRAKE PAD SCHEMATICS

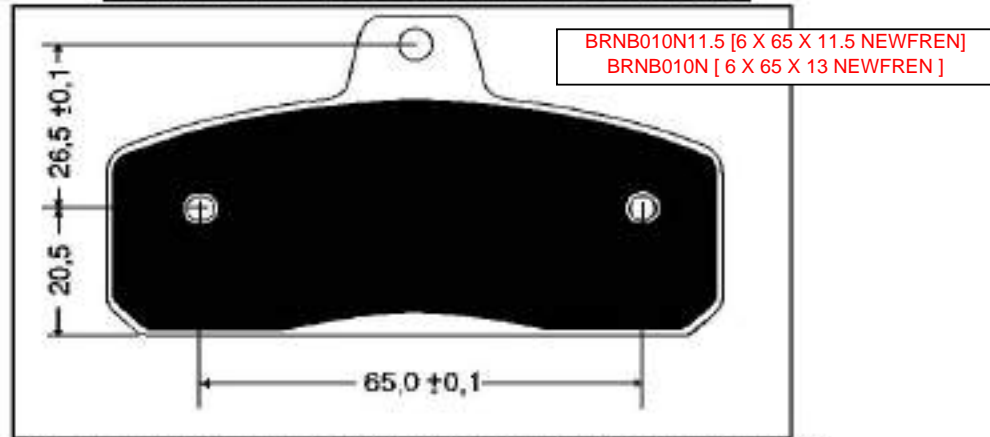

Figure 8 [65mm Centres 5mm Threaded Holes] 16mm Thick
 Figure 8A [65mm Centres 6mm Threaded Holes] 13mm & 14mm Thick
 Figure 8B [65mm Centres 6mm Threaded Holes] 16mm Thick

BRCR013 [GENUINE]
 BRCR013B [NEWFREN]

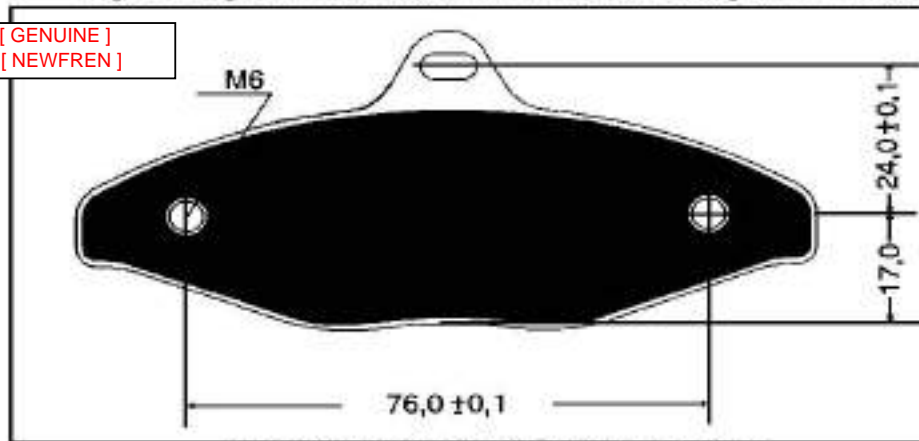

Figure 9 CRG/PRD/KALI 4 Spot Caliper

BRTK020 [GENUINE OTK BS2 BRAKES]
 BRTK015N [NEWFREN FD0285]

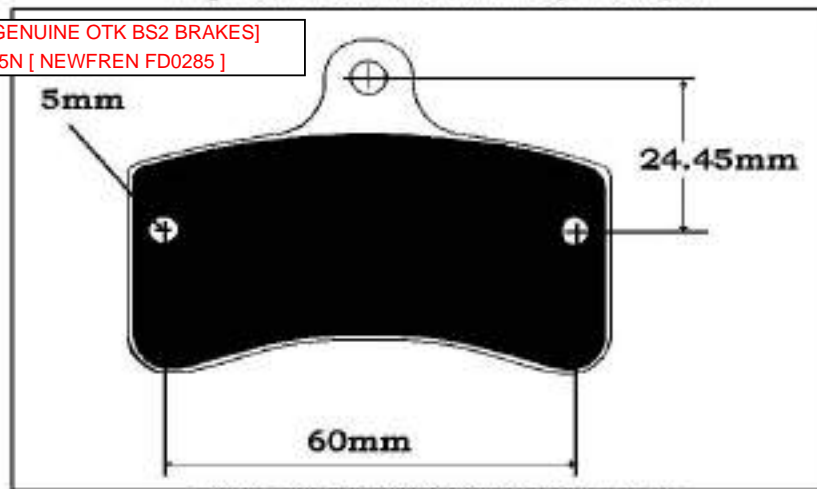

Figure 10 TONY/KOSMIC KART Late

SAME AS TRULI KART JT2 - JT3 up to late 2004

Newfren Brake Pads

new release

Australian Gokart Spares have released a new range of Kart Brake Pads into Australia manufactured by one of the largest brake material & brake pad manufacturer in Europe. These pads made from the highest grade of brake friction material . Due to the high demand of quality brake pads used in karting in Europe the Newfren name is at the top of the list when kart brake pads are required.

 <p>ARROW / DENT brake pads AX6 on 2 & 4 spot 15mm thick Medium Compound part number BRDE004NR</p>	 <p>54mm 71.5mm Tony / Kosmic / Truli 5mm X 60mm C to C 16mm Thick part number BRTK015N</p>	 <p>57.4mm 44mm 9mm Thick Tony/kosmic/Truli FA Kart/Esprit part number BRTK015N1</p>	 <p>55.5mm 90.5mm Tony Kart 5mm X 60mm C to C part number BRTK015N Birel/Monaco 6mm X 65mm C to C 13mm part number BRNB010N</p>
 <p>52mm 85mm CRG/KALI VEN91 74mm X 6mm C to C X 14mm part number BRCR013N</p>	 <p>48.5mm 108mm CRG/KALI VEN99 76mm X 6mm C to C 13.7mm part number BRCR013B</p>	 <p>50.5mm 59.9mm 12mm Thick CRG/MARANELLO/DR VEN05 part number BRCR016V05N</p>	
 <p>37mm 94mm UNIVERSAL/ALLKART AZZURRO/KSI 6mm X 56mm C to C X 16mm part number BRAK001B</p>	 <p>53mm 135mm BIREL 90mm X 6mm C to C X 14.7mm 135mm X 53mm part number BRBI001</p>	 <p>39mm 99mm UNIVERSAL/KSI/DAP/PCR 6mm X 56mm C to C X 17.3mm part number BRTL001N 6mm X 65mm C to C X 17.3mm part number BRPCR001</p>	

ARROW/DENT BRAKE PADS

Having problems with hard brake pads that will not stop , do not give you the braking you require to brake later for the winning edge . These new pads have been extensively tested and give the driver much more feel and enables him or her to modulate their braking to obtain maximum braking.

Newfren is one the largest motor cycle brake pads manufacture in Europe and have the technology to produce the a superior kart pad. Newfren was been making pads for the well known European kart manufactures for many years and in conjunction with Australian Gokart Spares have produced a pad that is a medium wear and has a medium/soft feel.

ARROW / DENT brake pads

AX6 on 2 & 4 spot

15mm thick Medium Compound

part number **BRDE004NR1.6**

11mm thick Medium Compound

part number **BRDE004AN1.6**



ALSO in the following Compounds

DENT brake pad 15mm thick



BRDE004NR1.1

soft compound [1.1]

15mm thick

BRDE004NR

hard compound [N64]

15mm thick

DENT Hydraulic 2 & 4 spot

DENT brake pad 11mm thick



BRDE004NR/11

soft compound [1.1]

11mm thick

hard compound [N64]

11mm thick

DENT Mechanical & early Hydraulic
DENT X3 self adjusting Hydraulic

NEWFREN BRAKE PAD SELECTION

UNIVERSAL BRAKE PAD [KIDNEY SHAPE]

Universal brake pad 56mm centre to centre 16mm thick
 Suits
 KSI Brakes , Swiss Hutless hydraulic & mechanical
 DAP , Allkart 2 spot , Foster [Azzurro early]
 Azzurro Z3 [red billet] ,Benson Mechanical



soft compound [1.1]



hard compound [N64]

UNIVERSAL BRAKE PAD [SQUARE BLOCK TYPE]

56mm centre to centre 16mm thick
 Suits

DAP , KSI , Benson mechanical , PCR , Tecno



soft compound [1.1]



hard compound [N64]

65mm centre to centre 16mm thick

Suits
 Top kart



9mm Thick
 Tony/kosmic/Truli
 FA Kart/Esprint
 Tony/kosmic/Truli
 part number **BRTK015N1**

71.5mm
 Tony / Kosmic /Truli
 5mm X 60mm C to C
 16mm Thick
 part number **BRTK015N**

55.5mm
 90.5mm
 Tony Kart
 5mm X 60mm C to C
 part number **BRTK015N**
 Birel/Monaco
 6mm X 65mm C to C 13mm
 part number **BRNB010N**

CRG Brake pads

KP Brake pads



BRCR016V05N
 VEN 05



BRCR013B
 VEN 99 [4 spot]



BRCR013N
 VEN 91 [2 spot]



BRKP002

BRAKE SHIMS

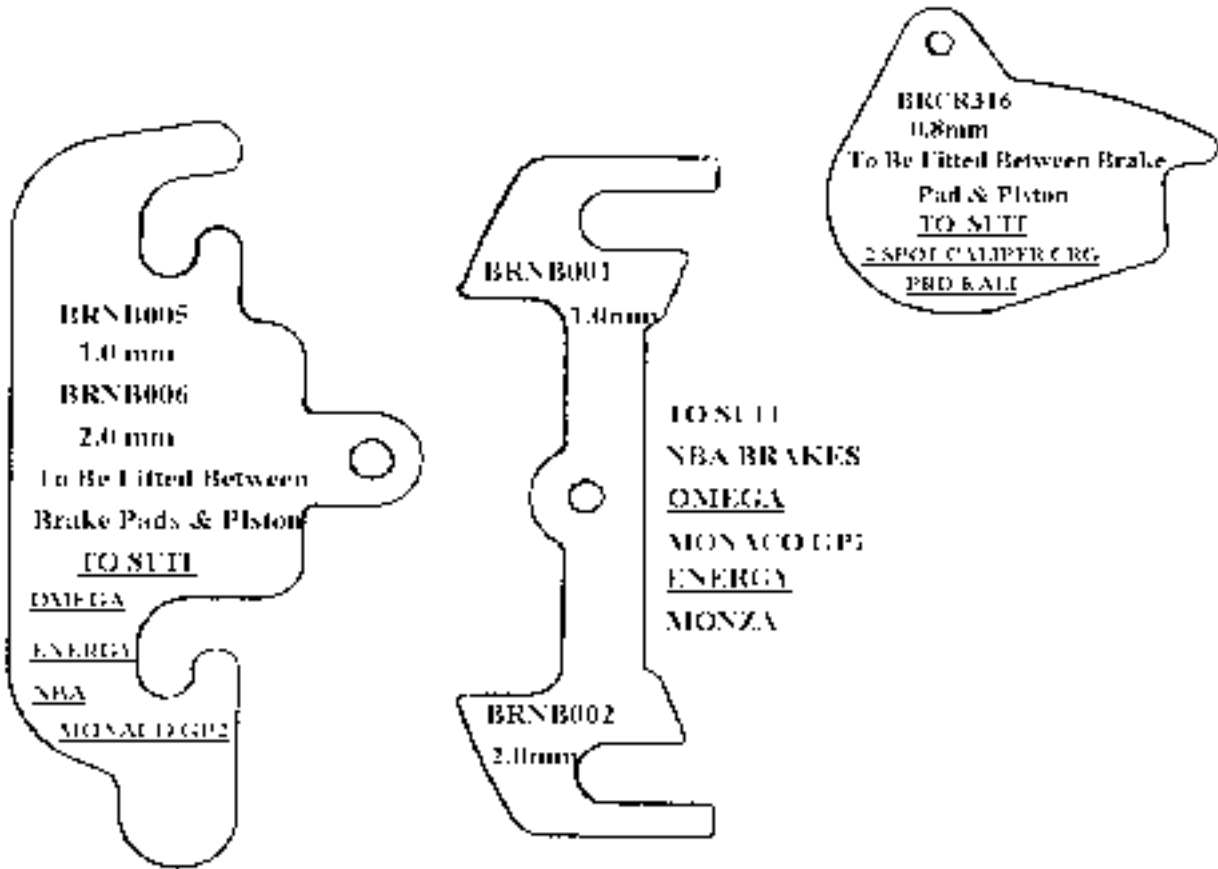

The Above Shims To Be Fitted Between Caliper Halves

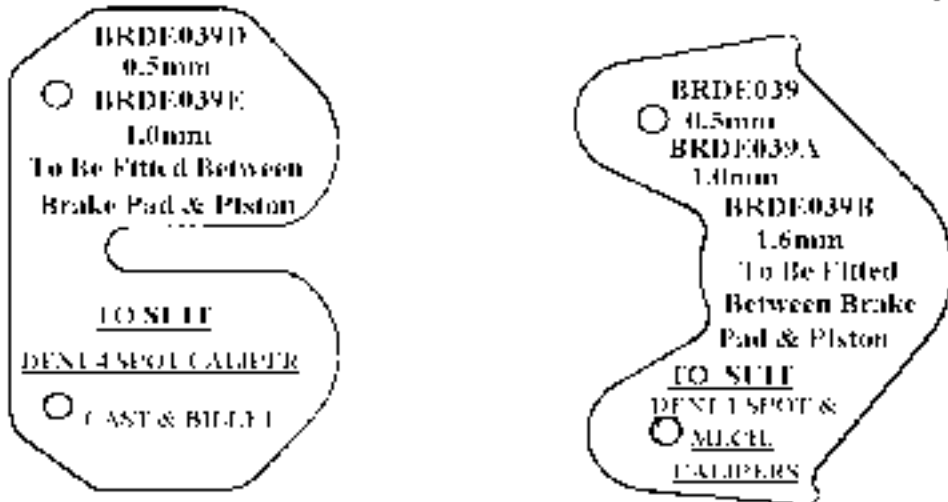

BRAKE PARTS PADS	F I G	SOFT COMPOUND	MED COMPOUND	MOTORQUALITY RACE COMP	HARD COMPOUND
MAKE/MODEL OF KART					
ALLKART Hydraulic 2 Spot	3A			BRAK001B	BRUN013B
ALLKART Hydraulic 4 Spot	3B			BRAK0013	
ALLKART Hydraulic 4 Spot	8A				
AZZURRO Hydraulic [Foster]	4			BRAK001B	BRUN013B
AZZURRO Hydraulic [BILLET]	4			BRAK001B	BRUN013B
BENSON Hydraulic	4			BRAK001B	BRUN013B
BENSON Mechanical	4			BRAK001B	BRUN013B
BIREL Hydraulic	8B			BRNB010NB	
CRG Hydraulic Early	5B	BRCR013KSTS		BRCR013C	BRCR013KSIH
CRG Hydraulic/Mechanical	6	BRCR013KSTS		BRCR013C	BRCR013KSIH
CRG/KALI Hydraulic 4 Spot	9		BRCR013A	BRCR013B	BRCR013
CRG/KALI Hydraulic 4 Spot-Brembo	9		BRCR014		
DINO Hydraulic/Mechanical	2	BRDI001A			
DPE DEMON X8 Hyd. KP Brakes	7				BRKP002
DPE DEMON XP-XP2 Hyd Dent	1	Note [4] BRDE004A		Note [4] BRDE004N	Note [4] BRDE004B
DPE ARROW A9S Mech/Dino	2	BRDI001A			
DPE ARROW A9S Hyd/KP Brakes	7				BRKP002
DPE ARROW AX5 Mech/Dino	2	BRDI001A			
DPE ARROW AX5 Mech/Dent	1	Note [4] BRDE004A		Note [4] BRDE004N	Note [4] BRDE004B
DPE ARROW AX5 Hyd/Dent	1	Note [4] BRDE004A		Note [4] BRDE004N	Note [4] BRDE004B
DPE MIDGET/ROOKIE Mech	1	Note [4] BRDE004A		Note [4] BRDE004N	Note [4] BRDE004B
DPE MIDGET/ROOKIE Hyd/Dent	1	Note [4] BRDE004A		Note [4] BRDE004N	Note [4] BRDE004B
DPE ARROW AX6 Hyd/Dent	1	Note [4] BRDE004A		Note [4] BRDE004N	Note [4] BRDE004B
DPE ARROW AX6 Mech/Dent	1	Note [4] BRDE004A		Note [4] BRDE004N	Note [4] BRDE004B
DPE ARROW AX6 CIK Hyd	1				
DPE ARROW AX6 SILVER	1			Note [3] BRDE004NR	Note [3] BRDE004C
DPE ARROW AX7 2000 CIK	1			Note [3] BRDE004NR	Note [3] BRDE004C
DPE ARROW AX8 ALL XE28, X1	1			Note [3] BRDE004NR	Note [3] BRDE004C
ENERGY Hydraulic	8B			Note [1] BRNB010N	
FULLERTON Hydraulic	5A		BRTK010N		
GOLD KART Hydraulic	8B		Note [1] BRNB010N		
HASSE KART Hydraulic	8	Note [1]	BRTK013N OR BRTK014N		
KOSMIC			BRTK015N		
KP BRAKES					BRKP002
MAC MINARELLI Hydraulic	5		BRTK001		
MERLIN KART	8B		BRNB010NC		
MIKE WILSON Hyd .[Early]	8		BRTK014N		
MIKE WILSON Hyd . [Late]	8A		BRMW010N		
MONACO Mechanical	1	Note [4] BRDE004A		Note [4] BRDE004N	Note [4] BRDE004B
MONACO Hydraulic/Dent	1	Note [4] BRDE004A		Note [4] BRDE004N	Note [4] BRDE004B
MONACO Hydraulic GP2 MBA	8A		BRNB010NC	BRNB010NB	
MONACO Hydraulic GP3 MBA	8A		BRNB010NC	BRNB010NB	
MONACO Hydraulic GP4 MBA	8A		BRNB010NC	BRNB010NB	
MONACO Hydraulic GP5&6 MBA	1	Note [4] BRDE004A		Note [4] BRDE004N	Note [4] BRDE004B
MONZA Hydraulic KSI	5		BRTK001		
MONZA Hydraulic NBA	8A			BRNB010NB	
Note [1] BRNB010N IS 16MM THICK & REQUIRES EXTRA SHIMS [NBA CALIPERS USE BRNB001/2] BRTK013N IS 13MM THICK BRTK014N IS 16MM THICK			Note [2] BRAK0012 Brake Pads Are Slightly Larger Pad Area & Has A Lug For Front Secure Pin [ONLY CAN BE USED WITH AN EDWARDS 100mm SPIGOT CARRIER]		Note [3] 15mm Thick Note [4] 11mm Thick

BRAKE PARTS PADS	F I G	SOFT COMPOUND	MED COMPOUND	MOTORQUALITY RACE COMP	HARD COMPOUND
MAKE/MODEL OF KART					
OMEGA Mechanical Benson	3A			BRK001B	
OMEGA Hydraulic Foster	4			BRK001B	BRUN013B
OMEGA Hydraulic KSI	5		BRTK001		
OMEGA Hydraulic Dent	1	BRDE004A		BRDE004N	BRDE004B
OMEGA Hyd Swiss Hutless	4			BRK001B	BRUN013B
OMEGA Hydraulic NBA	8B	BRRR006	BRRR006A	Note 1 BRNB010NB	Note 1 BRNB010NC
OMEGA LATE DENT	1			BRDE044NR	BRDE004C
P.C.R. Hydraulic	5		BRTK001		
P.C.R. Hydraulic Late	5B		BRPCR001		
SHADOW Mechanical	4			BRK001B	BRUN013B
SPEED KART Mechanical	4			BRK001B	BRUN013B
SPEED KART Hydraulic					
SWISS HUTLESS Mechanical	4		BRUN013C	BRK001B	BRUN013B
SWISS HUTLESS Hydraulic	4		BRUN013C	BRK001B	BRUN013B
TECNO Hydraulic	5B		BRPCR001		
TIBI KART Hydraulic	8B	BRRR006	BRRR006A	Note1 BRNB010N	BRRR006B
TIBI KART Hydraulic Late	8B		BRTK016N		
TONY KART Rookie Mech	3		BRTK013N		
TONY KART Esprit Hydraulic	8		Note [1] BRTK013N OR BRTK014N		
TONY KART Formula Hyd	8		Note [1] BRTK013N OR BRTK014N		
TONT KART Extreme Hyd	10		BRTK015N		
TONY KART Exagone Hyd	10		BRTK015A		
TONY KART Exagone Hyd Brembo	10		BRTK015B		
TOP KART Hydraulic [Early]	5A		Note [1] BRTK010N		
TOP KART Hydraulic [Late]	8B		BRNB010N		
TRULI KART JT2 & 3 TO LATE 2004			BRTK020		
TRULI KART JT3 ON LATE 2004			BRTK021		
WILL KART Hydraulic	8B		BRNB010N		
FRONT BRAKE PADS					
45mm X 4mm X 10mm THICK			BRFB001		
60mm X 6mm X 10mm THICK			BRFB010		
Note Part Numbers		Part Numbers		Note [1]	
BR-Brake Section		TK-Tony Kart		BRNB010N IS 16MM THICK & REQUIRES	
DE-Dent Brakes		MM-Mac Minarelli		EXTRA SHIMS [NBA CALIPERS USE BRNB001/2]	
KS-KSI Brakes		NB-NBA Brakes [Monaco Etc]		BRTK013N IS 13MM THICK	
SH-Swiss Hutless		AK-Allkart , MW- Mike Willson		BRTK014N IS 16MM THICK	

BRAKE SCHEMATICS

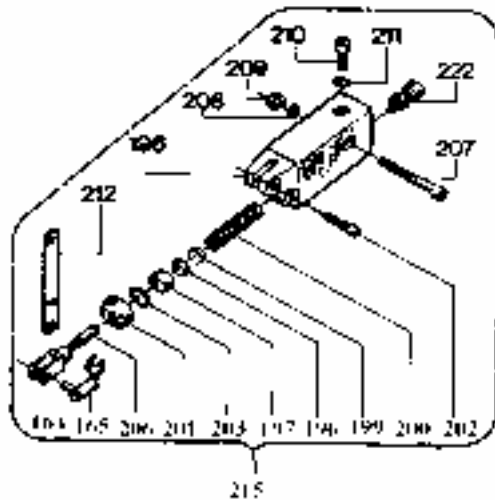

HYDRAULIC MASTER CYLINDER

HYDRAULIC CALIPER

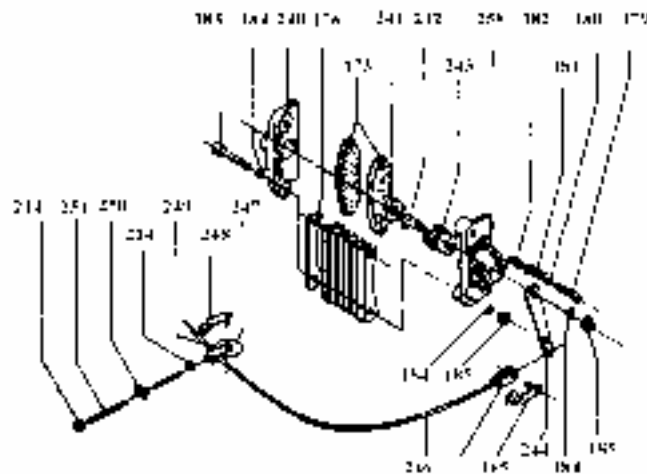
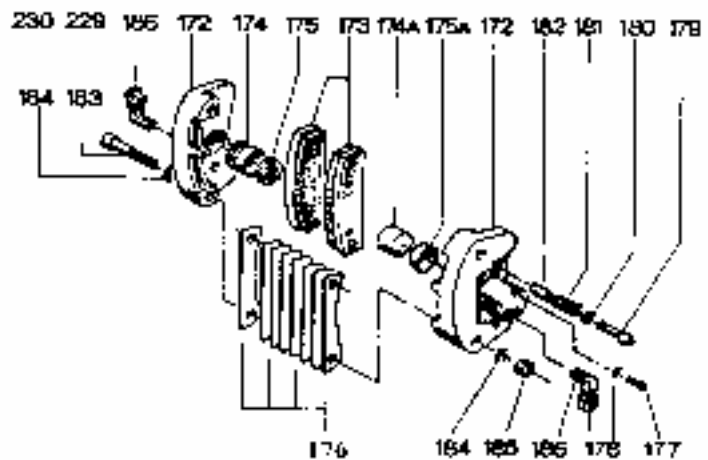

MECHANICAL CALIPER



CRG Brake Systems

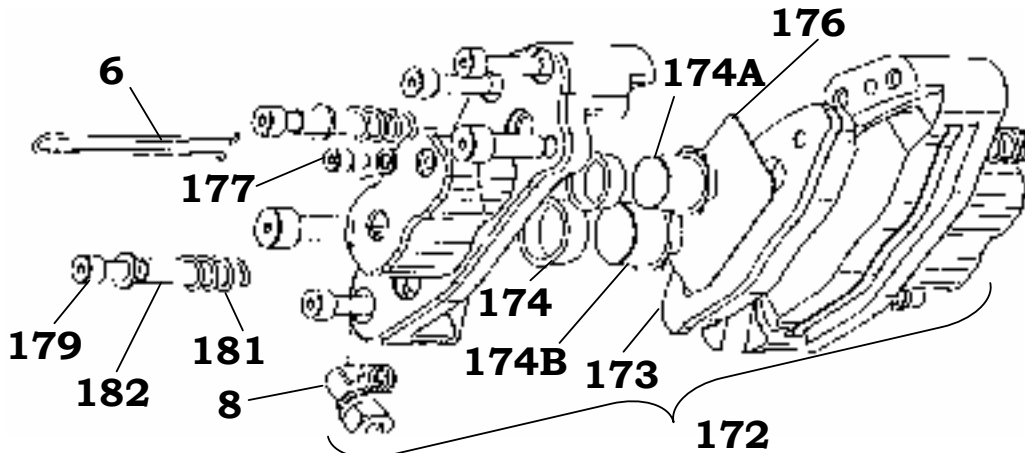

Billet 4 spot Caliper VEN99

BRAKE CALIPER KIT

174 **BRKIT301** X 2
BRKIT300 X 2

BRAKE PADS

BRCR013 [GENUINE]
BRCR013A [NON GENUINE]
BRCR013B [NEWFREN]

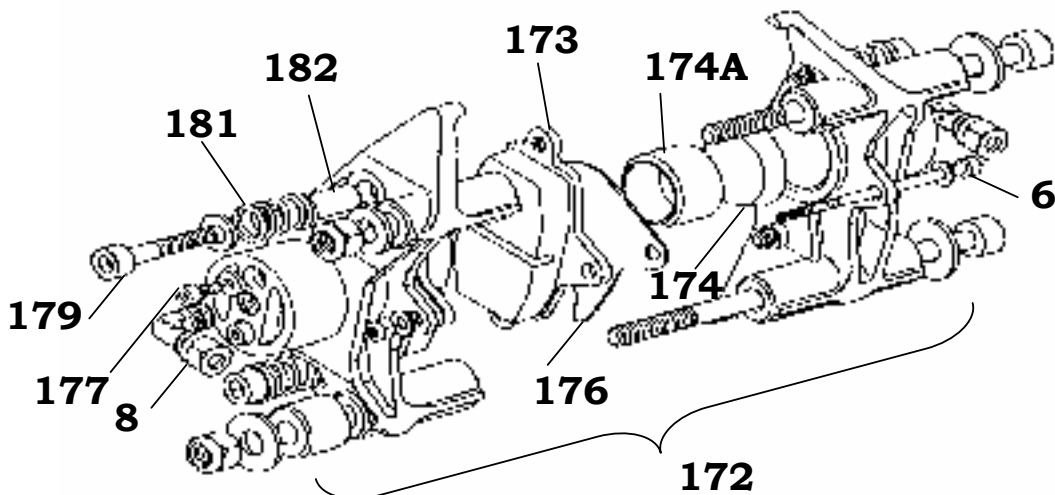

Cast 2 spot Caliper VEN91

BRAKE PADS

BRAKE CALIPER KIT

BRKIT306



CRG & MARANELLO



MASTER CYLINDER KIT [BREMBO / 2000 up / VEN 04 & 05]

BRCRG160A X 2

SAME AS **BRKIT408A** X 2

BRCR013N [NEWFREN]
BRCR013KSIH [NON GENUINE SOFT]
BRCR013KSIH [NON GENUINE HARD]
BRCR016V05 [CRG VEN05 NON GENUINE]

BRAKE PARTS HYDRAULIC		F I G	ALLKART	ALLKART	AZZURRO	AZZURRO	DAP
MASTER/CYL PARTS			2 SPOT CAST .875" DIA	4 SPOT BILLET .875" DIA	FOSTER [Cast] .875" DIA	2 SPOT BILLET .875" DIA	2 SPOT .875" DIA
I.D. Pictures							
ASSEMBLY	215						
BOOT	201	BRBOOT002	BRBOOT002	BRBOOT001	BRBOOT003		
BOLT CAP	210						
BOLT LEVER PIVOT CAP	202 210	NBC810	NBC810				
CAP SEAL	211						
FITTING STRAIGHT [NYLON]	222	BR067	BR067	BR068M	BR068A/BR067		
FITTING RIGHT A/L [NYLON]	186	BR067A	BR067A				
FITTING TEE [NYLON]		BR067C	BR067C				
LEVER	212						
PUSH ROD	206						
PISTON	197	BRAK101 [NOTE 1]		BRAZ062C	BRAZ062C		
PISTON SEAL PRIMARY	196	BRKIT301	BRKIT301	BRAZ062A	BRAZ062A	BRKIT408A	
PISTON SEAL SECONDARY				BRAZ062B	BRKIT301A	BRDA200	
SPRING	200						
MOUNT/SPACING-BOLT SIZE	207	38mm X 8mm	38mm X 8mm	35mm X 8mm	30mm X 8mm		

CALIPER PARTS		1.00" DIA	.75"/.875" DIA	30mm	30mm	1.00" DIA
ID Pictures						1.25" DIA
ASSEMBLY	172					
ADJUSTER						
ADJUSTER NUT						
BLEEDER SCREW	177	NBC516	NBC416	NBC516	NBC516	
BOLT PAD SECURE						
BOLT PAD RETURN	179	BRSH021	BRSH021			
PISTON SEAL PRIMARY		BRKIT307	BRKIT301	BRAZ064	BRAZ064	BRSH180160
PISTON SEAL SECONDARY	174					BRDA300[1"] BRNB301[1.2
PISTON CALIPER	176	BRAK315B	Note [2]	BRAZ064A	BRAZ064A	
SHIM ADJUSTER 0.5mm	176	BRAK300	BRAK210			
SHIM ADJUSTER 1.0mm	176	BRAK301	BRAK211	BRAZ065	BRAZ065	
SPRING PAD RETURN	181	BRSH026	BRSH026	BRSH026	BRSH026	
SLEEVE PAD RETURN	182	BRSH035	BRSH035			
MOUNT/SPACING-BOLT SIZE	183	80mmX8mm	80mmX8m	80mmX10mm	80mmX10mm	
Note [1] Allkart M/C Piston .875DIA X 22mm Long 13mm Depth		Note [2] Caliper Pistons ALKART .75" BRAK315 .875" BRAK315A			2004 LATE DAP 1.25" CUPS	

BENSON Mechanical Brake Caliper



BR201



BRAK001B1.1 [soft]

BRAK001B [hard]

16mm THICK
56mm C to C X 6mm THREAED











BR200





BRBE028

	DESCRIPTION	CENTRE MOUNT	Dimensions
1	COMPLETE BRAKE ASSY INC CABLES		
4	BRAKE PADS BENSON	BRBE008	56mm centre to centre 6mm
4	BRAKE PADS NEWFREN	BRAK001B	56mm centre to centre 6mm
6	SPACER BETWEEN HOUSING	BRSH036	
7	BOLT PAD RETAINING	NBC635	6mm X 35mm CAP HEAD
8	SPRING PAD RETAINING	BRBE028	13mmOD X 9.5mmID X 24mm
9	PAD SLEEVE RETAINING	BRBE034	9.5mmOD X 8mmID X 28mm
11	CABLE LONG	BR200	1150mm
12	CABLE SHORT	BR201	390mm
13	CLEVIS ARM/PULLEY WHEEL	BR213	
	MOUNTING SPACING	NBC875	80mm X 8mm







BRAKE PARTS		F I G	DENT	DENT	DENT	DPE	DPE
HYDRAULIC			4 SPOT	2 SPOT	4 SPOT BILLIT	2 SPOT BILLET	2 SPOT BILLET
MASTER/CYL PARTS			.875" DIA	.875" DIA	.875" DIA	.875" DIA	.875" DIA
ID Pictures							
ASSEMBLY	196	NLA	NLA	NLA	NLA	NLA	BRDE042B
BOOT	201	BRDE055	BRDE055	BRDE055	BRDE055	BRDE055	BRDE/MC/BOOT AX8
BOLT CAP	210	BRDE056	BRDE056	BRDE056	BRDE056	BRDE056	
BOLT LEVER PIVOT	202						
CAP	210	BRDE061	BRDE061	BRDE061	BRDE061	BRDE061	BRDE/MC/TOP AX8
CAP SEAL	211	BRDE054	BRDE054	BRDE054	BRDE054	BRDE054	BRDE/MC/DIA AX8
FITTING STRAIGHT [NYLON]	222						
FITTING RIGHT A/L [NYLON]	186	BR068[2]	BR068	BR068[2]	BR068[2]	BR068[2]	BR068[2]
FITTING TEE [NYLON]			BR069		BR069		BR069
LEVER	212	BRDE057	BRDE057	BRDE057	BRDE057	BRDE057	BRDE/MC/LEV AX8
PUSH ROD	206						BRDE/MC/PR AX8
PISTON	197						BRDE/MC/P AX8
PISTON SEAL PRIMARY	196	KIT BRDE053 EARLY MODEL				BRDE053A	BRDE053A
PISTON SEAL SECONDARY		KIT BRDE053A LATE MODEL				BRDE053A	BRDE053A
SPRING	200						BRDE/MC/PS AX8
MOUNT/SPACING-BOLT SIZE	207	43mm X 6mm	43mm X 6mm	43mm X 6mm	43mm X 6mm	43mm X 6mm	43mm X 6mm

CALIPER PARTS		1.25" DIA	.875" DIA	1.0" DIA	1.25" DIA	1.25" DIA
ID Pictures						
ASSEMBLY	172	Early Cast NLA	NLA	NLA	BRDE041C	BRDE041C
ADJUSTER			BRDE047			
ADJUSTER NUT			NBC6			
BLEEDER SCREW	177	BRDE046	BRDE046	BRDE046	BRDE046	BRDE046
BOLT PAD SECURE					Note [1]	Note [1]
BOLT PAD RETURN	179	BRDE022	BRDE022	BRDE022	NBC535	NBC535
KIT O/HAUL		BRDE0441	BRDE044	BRDE0442	BRDE0441	BRDE0441
PISTON CALIPER	174	BRDE043A	BRDE043	BRDE043B	BRDE043A	BRDE043A
SHIM ADJUSTER 0.5mm	176	BRDE039	BRDE039D	BRDE039D	BRDE039	BRDE039
SHIM ADJUSTER 1.0mm	176	BRDE039A	BRDE039E	BRDE039E	BRDE039A	BRDE039A
SHIM ADJUSTER 2.0 mm	176	BRDE039B			BRDE039B	BRDE039B
SPRING PAD RETURN	181	BRDE027	BRDE027	BRDE027	BRDE048	BRDE048
SLEEVE PAD RETURN	182				BRDE047A	BRDE047A
MOUNT/SPACING-BOLT SIZE	183	96mm X 8mm	86mm X 8mm	96mm X 6mm	96mm x 8mm	96mm x 8mm
Note [1] Pin BRDE047B [2Used] Spring Clip BRDE047C [1Used] Washer BRDE047D [2 Used]						

BRAKE HYDRAULIC SEALS

<p>DAP Master Cylinder .875" Dia</p>  <p>BRDA200 BRKIT408A</p> <p>Early DAP hydraulic brake master cylinder seal sold individually</p>	<p>DAP Caliper 1" Dia</p>  <p>Early DAP hydraulic brake Caliper secondary seals sold individually [2 per caliper]</p> <p>BRDA300</p>  <p>Early DAP hydraulic brake Caliper primary seals sold individually [2 per caliper]</p> <p>BRS180160</p>
<p>R/R UNIVERSAL MASTER CYLINDER BOOTS</p>  <p>BRBOOT001 BRBOOT001BL</p> <p>BRBOOT001BLX</p>	

DENT/ARROW BRAKE HYDRAULIC PARTS

<p>DENT/ARROW BRAKE MASTER CYLINDER EARLY CAST MASTER [BLACK]</p>  <p>BRDE053 BRDI025/BOOT</p>	 <p>BRDE061 [CAST]</p>  <p>BRDE054 [CAST]</p>
<p>LATER CAST MASTER [SILVER] & LATEST BILLET STYLE</p>  <p>BRDE053A CAST BILLET</p>	
<p>DENT/ARROW BRAKE CALIPER EARLY BLACK CAST 4 SPOT CALIPER WITH ADJUSTERS</p>  <p>BRDE044</p>	 <p>DUST BOOT [BILLET] BRDE/MC/BOOT AX8</p>
<p>CAST [SILVER] 2 SPOT CALIPER KIT</p>  <p>BRDE0441</p>	<p>BILLET 4 SPOT CALIPER KIT</p>  <p>BRDE0442</p>

BRAKE MASTER CYLINDER

DENT /DPE

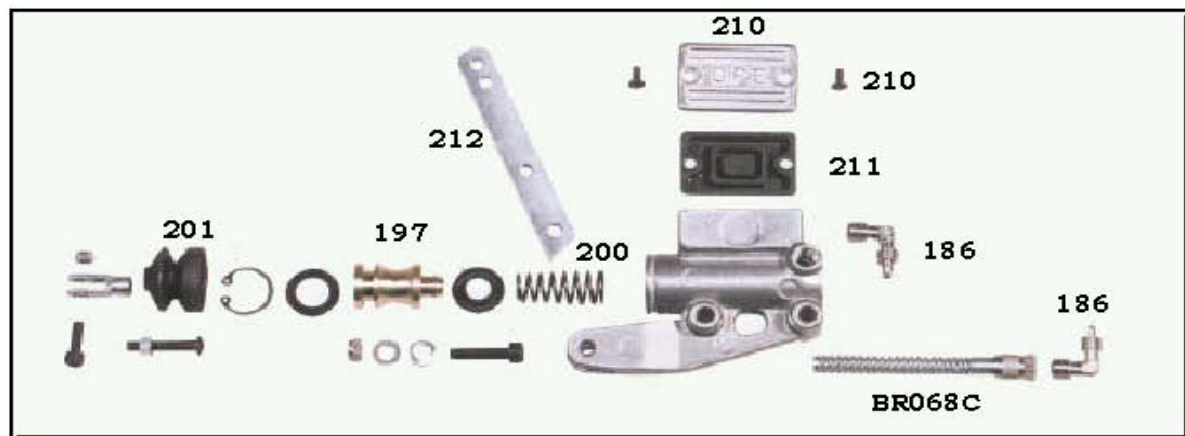
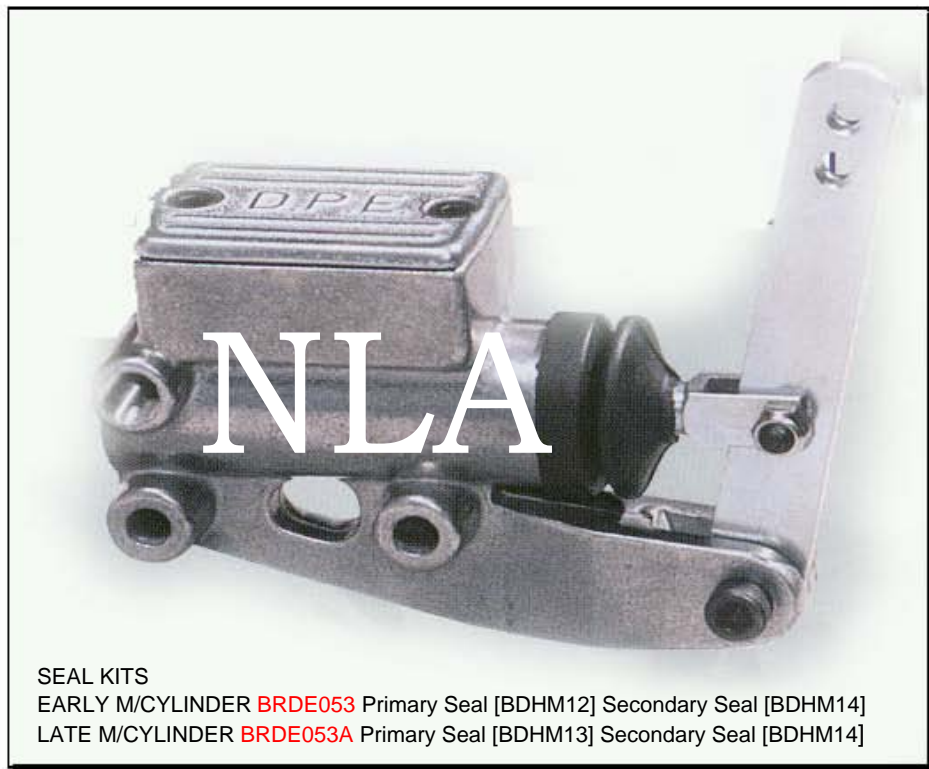

BRAKE MASTER CYLINDER DENT/DPE

FULL COMPENSATING TYPE SYSTEM

**WITH BUILT IN RESOVOIR TO MAINTAIN FLUID IN THE
SYSTEM AT ALL TIMES**

CAN BE USED WITH ANY CALIPER WHICH REQUIRES A .875" DIA CYL.

ARROW/DENT Brake Calipers

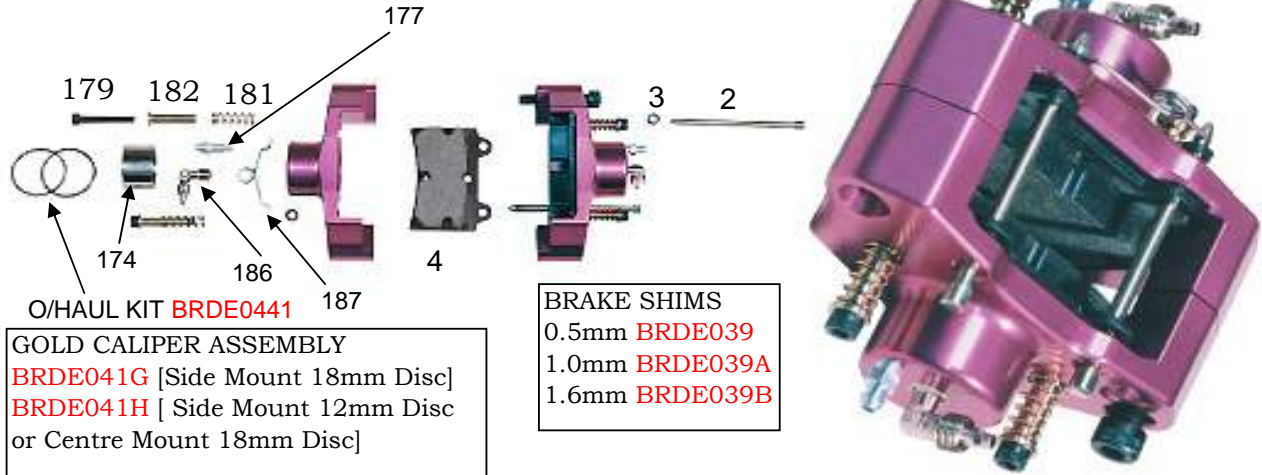

CALIPER ASSEMBLY **BRDE04HBLACK** [BLACK]

CALIPER ASSEMBLY **BRDE041C** [PURPLE]

2 SPOT BILLET BRAKE CALIPER



4 SPOT GOLD **BRDE041B1** [6mm side or 18mm centre mount]
 4 SPOT GOLD **BRDE041B2** [18mm side mount]
 4 SPOT BLACK **BRDE041B3** [18mm side B mount] AX9

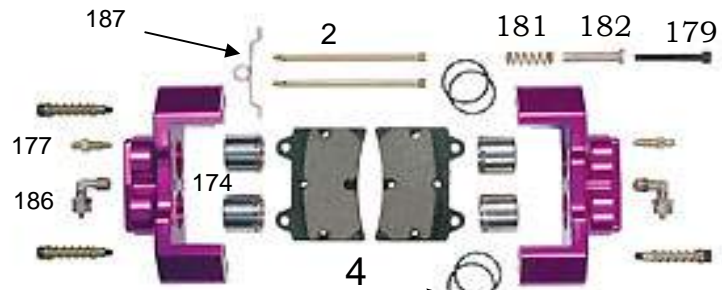

O/HAUL KIT **BRDE0442**

BRAKE SHIMS
 0.5mm **BRDE039D**
 1.0mm **BRDE039E**

BRAKE CALIPER 4 SPOT
 [Centre Mount 18mm Disc 1998]
BRDE041C 1998 on **BRDE041B**

CALIPER ASSEMBLY **BRDE041D** [2002]

4 SPOT BILLET BRAKE CALIPER

	DESCRIPTION	2 SPOT CALIPER	4 SPOT CALIPER
2	PIN SAFETY PAD RETAINER 63mm [Midget/Rookie]	BRDE047A2	
2	PIN SAFETY PAD RETAINER 75mm [2 SPOT]	BRDE047B	
2	PIN SAFETY PAD RETAINER 80mm [4 SPOT]		BRDE047A1
3	WASHER PIN SAFETY PAD RETAINER	BRDE047D	BRDE047D
4	BRAKE PADS ARROW [16MM THICK]	BRDE004C	BRDE004C
4	BRAKE PADS NEWFREN [16MM THICK]	BRDE004NR	BRDE004NR
174	PISTONS	BRDE043A	BRDE043B
177	BLEEDER SCREW	BRDE046	BRDE046
179	BOLT PAD RETAINING	NBC535	NBC535
179	BOLT PAD RETAINING	NBC535	NBC540
181	SPRING PAD RETAINING	BRDE048	BRDE048
181	SPRING PAD RETAINING	BRDE048	BRDE048
182	SLEEVE PAD RETAINING 31.20mm [overall]	BRDE047A	BRDE047A
182	SLEEVE PAD RETAINING 36.00mm [overall]	BRDE047A	BRDE047A
186	FITTING HYDRAULIC 90 DEG	BR068	BR068
	SPACER BETWEEN CALIPER FOR SIDE MOUNT	BRDE038	BRDE038
187	CLIP SAFETY PIN	BRDE047C	BRDE047C

ARROW/DENT Mechanical Brake Caliper



BRAKE PADS
 11mm THICK BRDE004C
 11mm THICK BRDE004AN [hard]
 11mm THICK BRDE004AN1.1 [soft]



BR200



BR201

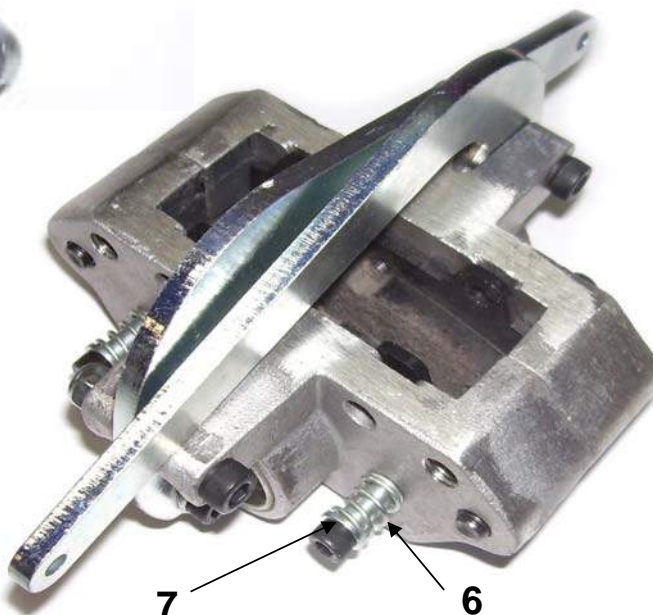

	DESCRIPTION	CENTRE MOUNT	SIDE MOUNT
1	COMPLETE BRAKE ASSY INC CABLES	BRDE071A	BRDE071
2	PIN SAFETY PAD RETAINER 63mm [Midget/Rookie]	BRDE047A2	BRDE047A2
3	WASHER PIN SAFETY PAD RETAINER	BRDE047D	BRDE047D
4	BRAKE PADS ARROW	BRDE004C	BRDE004C
4	BRAKE PADS [NEWFREN] 11MM THICK	BRDE004NR	BRDE004NR
5	PISTONS	BRDE082	BRDE082
6	SPACER BETWEEN HOUSING	BRDE038	BRDE038
7	BOLT PAD RETAINING	BRDE022	BRDE022
8	SPRING PAD RETAINING	BRDE027	BRDE027
9	SHIM BETWEEN PISTON & PAD .5mm	BRDE039D	BRDE039D
9	SHIM BETWEEN PISTON & PAD 1mm	BRDE039E	BRDE039E
10	ACUATING ARM	BRDE074	BRDE074
11	CABLE LONG	BR200	BR200
12	CABLE SHORT	BR201	BR201
13	CLEVIS ARM/PULLEY WHEEL	BR213	BR213

DPE/DENT BRAKE MASTER CYLINDERS



BDHM04-S

- BRHM30-Pushrod
- BDHM40-Piston
- BDHM42-Piston Clip
- BDHM45BW-Res. Top
- BDHM50B-Diaphragm
- BDHM20BS -Lever
- BDHM41 - Spring
- BDHM70B - O Ring
- RES BOLT
- BDM55B - KIT
- BRDE/MC/BOOT AX8 -Boot

- BRDE/MC/PR AX9
- BRDE/MC/P AX8
- BRDE/MC/PC AX8
- BRDE/MC/TOP AX8
- BRDE/MC/DIA AX8
- BRDE/MC/LEV AX8
- BRDE/MC/PS AX8
- BRDE/MC/RESO AX8

- BRDE042BGOLD
- BRDE042BLACK [AX9]

MOUNT SPACING 43mm

FITTED ON THE LATEST AX8 ARROW KARTS







BRDE042C
BIAS ADJUSTER

INTERNAL PARTS THE SAME AS SINGLE



- RIGHT SIDE BRDE042B2
- LEFT SIDE BRDE042B1



USED ON KARTS WITH FRONT BRAKE SYSTEM



BRAKE PARTS		F I G	CRG	CRG	KSI	MAC	MAC
HYDRAULIC			2 SPOT CAST	4 SPOT BILLET	2 SPOT	MINARELLI	MINARELLI
MASTER/CYL PARTS			.875" DIA	.500"DIA	.875" DIA	.875" DIA	.750" DIA
I.D. Pictures							
ASSEMBLY	196				NLA	NLA	NLA
BOOT	201	BRBOOT001	BRBOOT001	BRBOOT001			BRMM008A
BOLT CAP	210	NBC616	NBC616	NBC616			NBC816
BOLT LEVER PIVOT	202	KCRG163	KCRG163	NBC620			NBC620
CAP		NBC616	NBC616				
CAP SEAL							
FITTING STRAIGHT [NYLON]	222	BR067	BR067	BR068A/BR067	BR068A		BR068A
FITTING RIGHT A/L [NYLON]	186	BR067A	BR067A	BR068			
FITTING TEE [NYLON]		BR067C	BR067C	BR069	BR069		BR069
LEVER							
PUSH ROD	212	KCRG152	KCRG152				
PISTON	206	KCRG159					BRMM006
PISTON SEAL PRIMARY	197	BRKIT301	BRKIT200	BRKIT301	BRKIT301		BRKIT300
PISTON SEAL SECONDARY							
SPRING	200	KCRG152					BRMM007
MOUNT/SPACING-BOLT SIZE	207	50mmX8mm	50mmX8mm	35mm X 8mm			50mmX6mm

CALIPER PARTS		1.125" DIA	.75"/.875" DIA	1.125" DIA		1.00" DIA
ID Pictures		2 SPOT				
ASSEMBLY	172			NLA	NLA	NLA
ADJUSTER						
ADJUSTER NUT						
BLEEDER SCREW	177	NBC416	NBC416	NBC416		NBC416
BOLT PAD SECURE	6					
BOLT PAD RETURN	179	BRCR019 [NBC635]		BRSH021		NBC630
PISTON SEAL PRIMARY	174	BRKIT306	BRKIT301	BRKIT306		
PISTON SEAL SECONDARY	174		BRKIT300			
PISTON CALIPER	174A	BRAK315B	Note [2]			
SHIM ADJUSTER 0.5mm	176	BRAK300	BRAK305			
SHIM ADJUSTER 1.0mm	176	BRAK301	BRAK310	BRSH036		BRSH036
SPRING PAD RETURN	181	BRSH026		BRSH026		
SLEEVE PAD RETURN	182	BRSH035		BRSH035		
MOUNT/SPACING-BOLT SIZE	183	74mmX8mm	74mmX8mm	80mm X 8mm	80mmX8mm	80mmX8mm
Note [1]		Note [2] Caliper Piston Are Different Sizes				

BRAKE PARTS HYDRAULIC		F I G	MBA 2 SPOT .875" DIA	PCR 2 SPOT .875" DIA	DINO	MIKE WILSON 2 SPOT 4 SPOT .875" DIA
MASTER/CYL PARTS						
ID Pictures						
ASSEMBLY	196					can use BRRRK225XGOLD
BOOT	201	BRBOOT001				BRBOOT001
BOLT CAP	210	BRRRK411				
BOLT LEVER PIVOT	202					
CAP	210	BRRRK411				
CAP SEAL	211	BRRRK412				
FITTING STRAIGHT [NYLON]	222	BR068A	BR068A			
FITTING RIGHT A/L [NYLON]	186					
FITTING TEE [NYLON]						
LEVER	212	BRRRK406A				BRMW202
PUSH ROD	206					
PISTON	197	BRNB201 Note 5				BRMW201
PISTON SEAL PRIMARY	196	BRKIT301	BRKIT301			BRKIT301
PISTON SEAL SECONDARY		BRKIT301A				BRKIT301A
SPRING	200	BRNB203				
MOUNT/SPACING-BOLT SIZE	207	35mmX6mm	35mmX8mm			35mmX8mm

CALIPER PARTS		1.25" DIA			1.87"/30mm	.75/.875" DIA
ID Pictures						
BRAKE PADS	173					BRRR006A/B/C
ADJUSTER						
ADJUSTER NUT						
BLEEDER SCREW	177	NBC516			NBC416	
BOLT PAD SECURE						
BOLT PAD RETURN	179	BRRR023A Note3		BRDE022	NBC530	BRSH021
PISTON SEAL PRIMARY		BRNB301	BRKIT306		BRMW300A	BRSH178361
PISTON SEAL SECONDARY		BRNB3011				BRKIT408A
PISTON CALIPER	174	BRNB302				
SHIM ADJUSTER 1.0mm	176	BRNB001			BRNB001	BRAK211
SHIM ADJUSTER 2.0 mm	176	BRNB002			BRNB002	BRAK210 [0.6]
SPRING PAD RETURN	181	BRRR029 Note 2			BRRR029	BRSH026
SLEEVE PAD RETURN	182	BRRR030 Note4				BRSH035
MOUNT/SPACING-BOLT SIZE	183	85mmx10mm			85mmx10mm	85mmx10mm
Note 1 TonyKart Most Caliper Parts Of MW 2 Spot Caliper Fit TonyKart Caliper		Note 2 Can Use BRSH026 Note 3 Can Use BRSH035		Note 4 Can Use BRSH021 Note 5 Can Use BRRR407 Also use BRKIT408A & BRKIT408B		

BRAKE PARTS		F I G	RIGDETTI	RIGDETTI	SWISS	SWISS	TONY
HYDRAULIC			RIDOLFI	RIDOLFI	HUTLESS	HUTLESS	KART
MASTER/CYL PARTS			.875" DIA	.875" DIA	.750" DIA	.750" DIA	.500"DIA
ID. Pictures							TWIN MASTER CYLINDER
ASSEMBLY	215		BRRRK225				
BOOT	201	BRBOOT001	BRBOOT001	BRSH178210	BRSH178210		
BOLT CAP	210			BRSH178320	BRSH178310		
BOLT LEVER PIVOT	202	BRRRK413	BRRRK413	BRSH178400	BRSH178400		
CAP	210	BRRRK411	BRRRK411	BRSH178300	BRSH178300		
CAP SEAL	211	BRRRK412	BRRRK412	BRSH178330	BRSH178330		
FITTING STRAIGHT [NYLON]	222	BR067	BR067	BRSH178220	BRSH178220		
FITTING RIGHT A/L [NYLON]	186	BR067A	BR067A	BRSH180120	BRSH180120		
FITTING TEE [NYLON]		BR067C	BR067C	BRSH180130	BRSH180130		
LEVER	212	BRRRK406A	BRRRK406A	BRSH178130	BRSH178130		
PUSH ROD	206			BRSH178150	BRSH178150		
PISTON	197	BRRRK407	BRRRK407	BRSH178180	BRSH178180		
PISTON SEAL PRIMARY	196	BRKIT408A	BRKIT408A	BRSH178160	BRSH178160		
PISTON SEAL SECONDARY		BRKIT408B	BRKIT301A	BRSH178361	BRSH178361		
SPRING	200	BRRRK409	BRRRK409	BRSH178200	BRSH178200		
MOUNT/SPACING-BOLT SIZE	207	35mmX8mm	35mmX8mm				

CALIPER PARTS		30mm[1 3/13]	30mm[1 3/13]	25mm [1"]	27mm	30mm[1 3/16]
ID Pictures						2 SPOT
ASSEMBLY	172	BRRRK381	BRRRK381			
ADJUSTER						
ADJUSTER NUT						
BLEEDER SCREW	177	NBC416	NBC416	BRSH180200	BRSH180200	
BOLT PAD SECURE		[Note 1]NBC560	[Note 1]NBC560			
BOLT PAD RETURN	179	BRRR023A	BRRR023A	BRSH021	BRSH021	NBC530
PISTON SEAL PRIMARY		BRMW300A	BRMW300A	BRSH180160	BRSH180280	BRMW300A
PISTON SEAL SECONDARY	174					
PISTON CALIPER	176	BRRRK384	BRRRK384	BRSH180170	BRSH180170	
SHIM ADJUSTER 0.5mm	176					BRNB001
SHIM ADJUSTER 1.0mm	176	BRRRK385B	BRRRK385B	BRSH036	BRSH036	BRNB002
SPRING PAD RETURN	181	[Note 2]	[Note 2]	BRSH026	BRSH026	
SLEEVE PAD RETURN	182			BRSH035	BRSH035	
MOUNT/SPACING-BOLT SIZE	183	60mmX10mm	60mmX10mm	80mmX8mm	80mmX8mm	85mmX10mm
Note [1] Use NBC570 When Using 16mm Pads		Note [2] CRG & Early R/R Spring Are 22mm Long BRRR029 Late R/R Spring 18mm Long BRRR029A				

BRAKE CALIPER R/R GOLD

2 SPOT

Mounting Bolt Size & Spacing

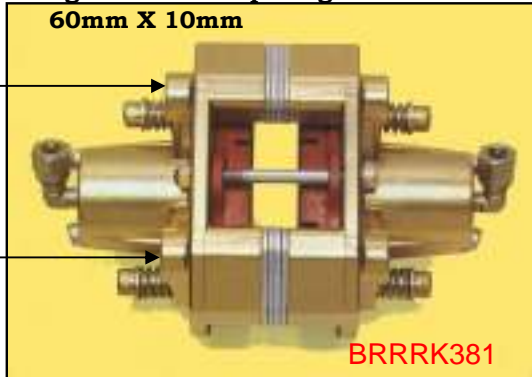

CALIPER ASSY
BRRRK381BLACK
 [2 SPOT]
BRRRK381BLACK4
 [4 SPOT]



BRSH021KIT

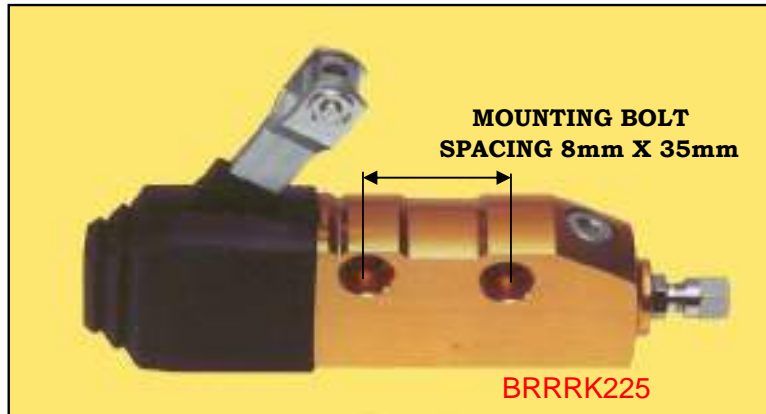

MASTER CYLINDER
 ASSEMBLY

BRRRK225BLACK
 [COLOUR BLACK]
BRRRK225T
 [COLOUR TITANIUM]



MASTER CYLINDER
 SPARE PARTS
 0.875" DIA



Righetti Ridolfi Brake Calipers

SMALL PISTON .750"

BRSH178361 [SEAL]

LARGE PISTON .825"

BRKIT408A [SEAL]

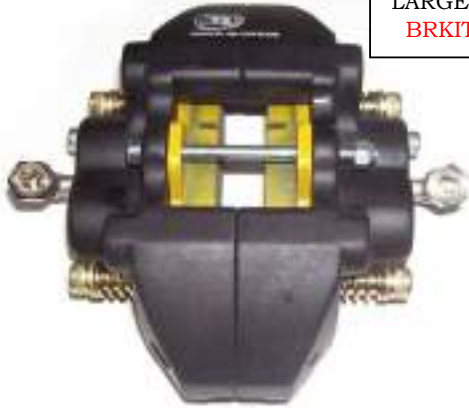

4 spot Brake Caliper

BRRRK3814BL [BLACK] BRRK3814G [GOLD]



BRRR006B MED 2 & 4 SPOT

14mm thick x 65mm bolt centres

BRNB010N [NEWREN] fits only 2 SPOT

13.5mm thick x 65mm bolt centres

2 spot Brake Caliper

BRRRK381BL

DESCRIPTION	2 SPOT CALIPER	4 SPOT CALIPER
CALIPER MOUNTING BOLTS & SPACING	12 X 60MM	12 X 60MM
BRAKE PAD MOUNTING BOLTS & SPACING	6 X 65MM	6 X 65MM
BRAKE CALIPER SEAL 19mm/.750" [2 PER CALIPER]		BRSH178361
BRAKE CALIPER SEAL 20mm/.875" [2 PER CALIPER]		BRKIT408A
BRAKE CALIPER SEAL 30mm/1.23" [2 PER CALIPER]	BRMW300	
BRAKE PADS NEWFREN 13.5mm THICK	BRNB010N	BRNB010N
BRAKE PADS RIGETTI RIDOLFI 14mm THICK	BRRR006B	BRRR006B
PISTONS	BRRRK384	
BLEEDER SCREW	NBC510	NBC510
BOLT PAD RETAINING	NBC630	NBC630
SPRING PAD RETAINING	BRRR029A	BRRR029A
SLEEVE PAD RETAINING 8 X 23MM	BRRR030	BRRR030
SLEEVE,BOLT & SPRING KIT	BRSH021KIT	BRSH021KIT
FITTING HYDRAULIC 90 DEG	BR068	BR068
SECURE SAFETY BOLT	NBC565	NBC565

Brake Master Cylinder RIGHETTI RIDOLFI



Hydraulic Brake Master Cylinder
full compensation reservoir type
7/8" Bore Diameter
35mm c to c x 6mm mounting
part number
BRRRK225XGOLD



Black with Transparent tank
part number
BRRRK225XBLACK



Gold with Transparent tank
part number
BRRRK225XGOLD



BRRRK225



Repair Kit [MAJOR]
part number
BRRRK225KIT2



Repair Kit [MINOR]
part number
BRRRK225KIT1



BRRRK225T



BRRRK225BLACK



BRRRK225KIT
[K299]



FILLER PLUG
BRRRK411

Righetti Ridolfi BRAKE CALIPER MOUNT BRACKETS



The caliper mounting bracket is designed to bolt to the rear axle bearing mounting bolts, 30mm, 40mm & 50mm bearing configurations.

4 SPOT [PISTON] BRAKE CALIPER



BRRK381BLACK

part number **BRRRBRACKET4SPOT**

2 SPOT [PISTON] BRAKE CALIPER

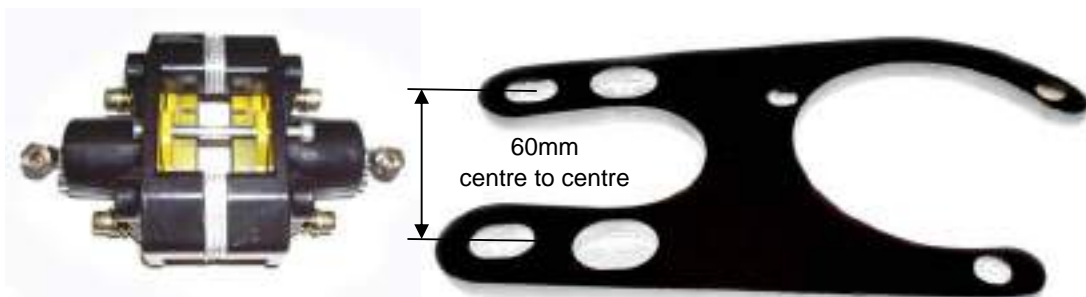

BRRR381BLACK

part number **BRRRBRACKET2SPOT**

KP BRAKE SYSTEMS

Complete KP Hydraulic brake system

These brake systems were fitted on the Arrow/Demon karts up to the early 90's. The brake system shown in the picture is the latest version which is the same as the early units except instead of using spring clips to hold the pads in its use's retaining bolts.

The mounting bolts & spacing both for the master cylinder & caliper are the same from the early to the latest versions.



BRAKE PADS

BRKP002



BRAKE MASTER CYLINDER ASSY

BRKP001A

BRKP001

PISTON M/CYLINDER COMPLETE [INC SEALS]

BRKP107A



BR202

M/CYLINDER PRIMARY SEAL DIA .750"

BRKP106A



BRKP106A

M/CYLINDER SECONDARY SEAL 'O' RING

BRKP106



M/CYLINDER DUST BOOT

M/CYLINDER LEVER & PUSH ROD ASSY

BRKP105



M/CYLINDER FILLER CAP & GASKET

CAP
GASKET

BRRRK411
BRRRK412



BRKP105

CALIPER ASSY

BRKP001B

BRAKE PADS

BRKP002

PISTON CALIPER COMPLETE [INC SEALS]

BRKP108



BRKP108

CALIPER KIT [inc O Rings & Seals]
To Suit DEMON X8 & ARROW A9S karts

BRKP113



2.65mm Dia X8 Caliper
O RING
3.50mm Dia X6 Caliper
O RING

CALIPER SECONDARY SEAL 'O' RING

BRKP114



CALIPER ADJUSTER SLEEVES

BRKP031



BRKP031

SPRING CLIPS TO RETAIN BRAKE PADS
LATE MODEL SHOULDER BOLT **BRKP027**
LATE MODEL BOLT SPRING **BRKP026**
CALIPER BLEEDER SCREWS **BRKP115**

BRKP025



BRAKE LINE NYLON **BR070**

BRAKE LINE SPRING NUTS
BR068C



BRAKE FITTINGS 90deg
BR068

BRAKE FITTINGS TEE
BR069A



OTK BRAKE SYSTEMS BS2



BROTK002/MAST
0029.CO



PISTON SEAL
BROTK004/S/BS5
Requires [1]



RETAINING CLIP
BROTK003/MC



FILLER PLUG

OTK BRAKE MASTER CYLINDER ASSEMBLY one of a pair fitted to Tony/Kosmic/FA/Truli & Exprit KARTS



BROTK003/SP



BROTK004/PIST
OTK BRAKE CALIPER BS2



BROTK004/M/BOOT2

REAR BRAKE CALIPER ASSEMBLY



part number BROTK001/CAL/BS2



NEWFREN
part number BRTK015N1
BS5-BS6
[FD0457]



GENUINE
part number BRTK020
[0100.F2]



part number BRMW300A

BRAKE PADS ADJUSTMENT SHIMS

BROTK004/CAL/SH9
[0082.B3.9]
BROTK004/CAL/SH



part number BROTK004/CAL



SLEEVE
BROTK004/CAL/SL



BOLT
NBC530



SPRING
BROTK004/CAL/SP



OTK BRAKE SYSTEMS BS5-6



PISTON SEAL
BROTK004/S/BS5



BROTK003/MC



OTK BRAKE MASTER CYLINDER ASSEMBLY one of a pair fitted to Tony/Kosmic/FA/Truli & Exprit KARTS



BROTK004/M/RES



BROTK004/M/RESL



BROTK004/M/REST



BROTK003/SP/BS5



BROTK004/P/BS5



BROTK004/M/BOOT
Short boot version

OTK BRAKE CALIPER SELF ADJUSTING BS5-6



part number BRTK001/CAL



BROTK004/CAL/BLEED



BR067

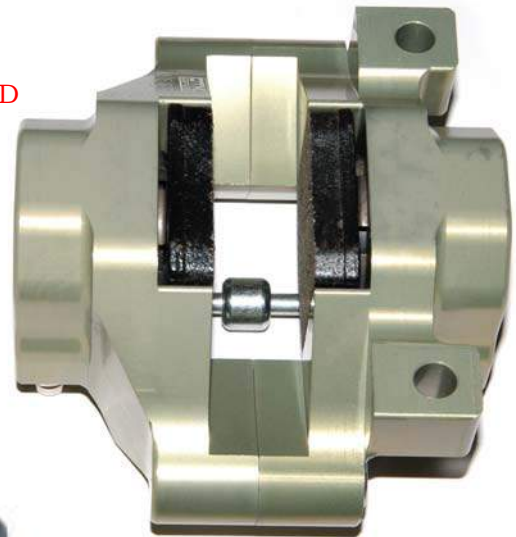

part number BRTK001/CAL



GENUINE
part number BRTK021
BS5-BS6
NEWFREN
part number BRTK020N1
[HARD]



OTK BRAKE SYSTEMS SA2-3



PISTON SEAL
BROTK004/S/BS5



BROTK003/MC

OTK BRAKE MASTER CYLINDER ASSEMBLY one of a pair fitted to Tony/Kosmic/FA/Truli & Exprit KARTS



BROTK004/M/RES



BROTK004/M/RESL



BROTK004/M/REST

BROTK001/M/SA2



BROTK003/SP/BS5



BROTK004/P/BS5



BROTK004/M/BOOT
Short boot version

OTK BRAKE CALIPER BSM



BROTL004/CAL/P



BROTK001/CAL/BSM

CADET KART
ROOKIE KART
JUNIOR KART
CLUBMAN KART



part number BRMW300A







GENUINE
part number BRTK023
BSM



BROTL004/CAL/P

BRAKE PARTS GENERAL		FIG	SOLID	VENTILATED	RADIALLY VENTILATED	ID PICTURES
BRAKE DISCS STEEL						
100mm x 195mm ROOKIE	145			BR131B		VENTILATED 
100mm x 215mm x 5mm	145			BR128A		
116mm x 218mm x 5mm	145			BR128		

CAST IRON					CROSS DRILLED
100mm x 205mm x 12mm DPE	145			BR129	
100mm x 210mm x 12mm KG	145			BR1292	
100mm x 210mm x 12mm SKM	145			BR130	
100mm x 208mm x 12mm ITAL	145			BR131	
100mm x 205mm x 18mm DPE 1998 WIDE VENT	145			Note [1] BR1290	
100mm x 205mm x 18mm WIDE VENT ITALSPORT	145			non genuine BR1290KSI	

BRAKE CARRIERS		76mm OD	100mm OD	116mm OD	
25mm x 6mm KEY Edwards	142		BR132	TR010	
30mm x 6mm KEY Edwards	142	BR132B	BR132A	TR011	
35mm x 6mm KEY Edwards	142	BR132B1	BR134	TR012	
30mm x 6/8mm KEY SKM	142		BR132C1		EDWARDS 
30mm x 8mm KEY Edwards	142		BR132C	TR011A	
35mm x 8mm KEY Edwards	142		BR134A	TR012A	
35mm x 8mm KEY R/R GOLD	142		BR134A1	TR012B	
40mm x 8mm KEY Edwards	142		BR134B	TR013	
40mm x 8mm/6mm KEY DPE GOLD ARROW	142		Note [2] BR134CDPE40G	Note [2] TR013ADPE40G	
40mm x 8mm/6mm KEY DPE PURPLE AX8 ARROW	142		BR134CDPE40P	TR013ADPE40P	
40mm x 8mm KEY R/R GOLD	142		BR134D	TR013B	
40mm x 8/6mm KEY SKM	142		BR134E	TR013C	
40mm x 8mm KEY Italsport	142		BR134FITAL40G	TR013A1	
50mm x 8mm KEY ARROW	142		BR134HDPE50P	TR013EDPE50P	
50mm x 8mm KEY SKM	142		BR134SKM50G	TR012ESKM50G	
50mm x 8mm KEY Italsport	142		BR134HITAL50G	TR013E	
Note [1] DPE Special Disc Is Wider & You Will Have To Space The Caliper Apart An Extra 6MM		Note [2] Both BR134C & TR012A Carriers Have 6MM & 8MM Keyways		Note [3] TONY KART Brake Disc & Carrier Can Be Replaced With Both BR1291 & With Any 100MM Brake Carriers As Long As You Use Both Parts.	

BRAKE DISCS



SLOTTED HOLES

STEEL

116mm X 218mm X 5mm Thick

BR128

100mm X 215mm X 5mm Thick

BR128A



CAST IRON RADIALLY VENTED DISC

ITALSPORT

100mm X 208mm X 12mm Thick

BR131

TONY KART [OTK] BRAKE DISC FLOATING WILL FIT 100mm HUB.
I.D. SPIGOT 100mm X 206 O.D. X 16mm

DPE BRAKE DISCS & CARRIERS

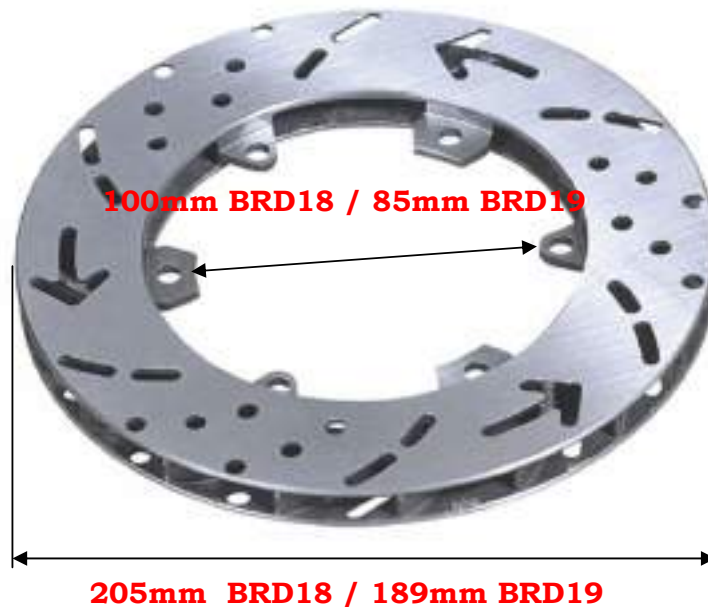

Is there no stopping DPE's innovation
 As well as manufacturing a large range of brake discs and hubs to suit most karts and applications, they have recently released their radial vented 'RADICALLY COOL' brake disc. Its unique design and construction ensures you'll never have to worry about brake fade again - yet in weights less than 980 grams. Match it to their GOLD BILLET Disc Hubs and you'll stop the opposition in their tracks every time.

BR1290 [BRD18] [Kartech]

BR1290KSI non genuine

18mm WIDE

100mm I.D. X 205mm O.D.

BILLET BRAKE CARRIER



40mm **BR 134CDPE40P** GUN METAL

50mm **BR134HDPE50P** GUN METAL

8mm & 6mm KEYS

FLOATING DISC TYPE



50mm **BR1290X1 [BRDH501]** X1 GUN METAL
BR134HDPE50X1B [BRDHB]

30mm **BR132C2** X1 GUN METAL

Righetti Ridolfi Brake Disc Hubs

100mm Spigot

30mm Axle 6mm & 8mm Keyway

2012 Star Type

Conventional Type



GOLD
[K729B-G]



BLACK
[K729B-N]



BR132CG/30
GOLD
[K606BG]



BR132CB/30
BLACK
[K606BN]

40mm Axle 8mm Keyway



BR134D/STAR



BR134DB/STAR
BR134DT/STAR



BR134D
BR134DT



BR134D40B

50mm Axle 8mm Keyway



BR134HRR50AL/GS



BR134HRR50AL/BLS



BR134HRR50AL/G



BR134HRR50AL/BL

50mm Axle 8mm Keyway FLOATING DISC



BR134HRR50FL/G



BR134HRR50FL/B

BRAKE DISCS RIGHETTI RIDOLFI



FRONT BRAKE DISC INOX [R/R]

BR131CRRF

[K447-150-30-D]

150mm X 3.0mm



CAST VENTILATED FRONT DISC

BR13RRFRH [RH]

[K346DS]

BR131RRFLH [LH]

[K346SS]

160mm X 12mm



REAR SELF-VENTILATED BRAKE DISC

BR1292

[K238SF]

210mm X 12mm W/HOLES

BR1292/200/18mm

[K239F]

200mm X 18mm W/HOLES



REAR SELF-VENTILATED BRAKE DISC

BR130

[K238SS]

210mm X 12mm W/GROVE

BR1292/200/18mmP

[K239]

200mm X 18mm PLAIN

BR1292/200/18mmG

200mm X 18mm W/GROVE

BRAKE DISCS RIGHETTI RIDOLFI



With cleaning groove
BR1292/200/18MMFG



BR134HRR50FL/B
50mm only



With cooling holes
BR1292/200/18MMF



BR134HRR50FL/G
50mm only





Plain
BR1292/200/18MMFP

2014 New Release by Righetti Ridolfi

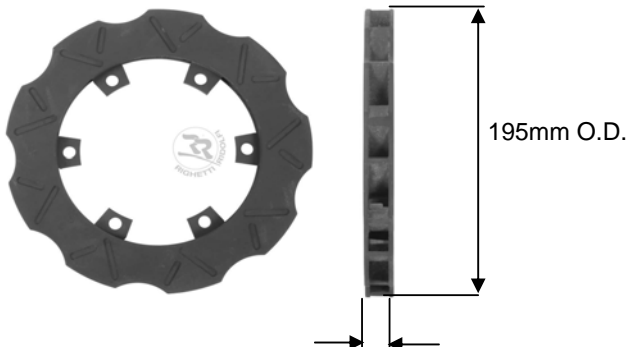
Floating rear brake Brake Disc to suit 50mm Diameter axles . Light weight construction in the carrier and brake disc keeps the rotating mass.



BR1292/195/18MMF

BRAKE PARTS GENERAL		FIG	STD	SPECIAL LONG	ID PICTURES
CABLES					
SHORT --390mm	246	BR201			 BR211A BR211B
LONG --1150mm	251	BR200			
LONG SIDE PULL --2000mm		BR203 [cable only]			
MASTER/CYL --670mm		BR202			
OUTER CABLE 400mm LONG		BR205			
CLEVIS CABLE	249	BR213			 BR212
CLEVIS ROD	164	BR213A Note [4]	Note [1] BR213A1		
CLEVIS PIN CLIP 6mm Dia	165	BR213B	BR213C		
BALANCE WHEEL	247	BR214			
U BOLT CLAMP		BR210			
ADJUSTER BRAKE 6mm	250	BR211 & BR211A			 BR212A [short] BR213A1 [long]
ADJUSTER THROTTLE 6mm	58	BR211 & BR211A	EPY693B & BR211B [R/R]		
ADJUSTER THROTTLE 4mm	58	BR212			
KSI CABLE BARREL		BR204 [2 for each cable]			

RODS		6mm DIA	KARTS	
175mm LONG	213	BR215	AX5/XP	 BR213A
240mm LONG	213	BR2151		
265mm LONG	213	BR2151A	AX8 JUNIOR	
305mm LONG	213	BR2151B	A & B MAX SHORT	
320mm LONG	213	BR2151C	AX8 28/30 30/32	
340mm LONG	213	BR2152		
355mm LONG	213	BR2152	AX8 EXT FRONT	
365mm LONG	213	BR2153		
400mm LONG	213	BR215A	CRG/PRD/KALI	
413mm LONG	213	BR215A1	AX6 SHORT FRONT	
430mm LONG	213	BR215B		
438mm LONG	213	BR215B1	AX6 STD FRONT	
490mm LONG	213	BR215C	AX6 EXT. FRONT	
600mm LONG	213	BR215C1		
470mm [To Suit Adjuster]	213	Note 3 BR215D	MONACO	
BRAKE ROD ADJUST. SPRING		BRNB310	MONACO	
BRAKE ROD ADJUST. KNOB		BRRRK456G	MONACO	
Note		Note [1] BR213A1 EURO SHORT BR213A2 EURO LONG	Note [2] BR070 Supplied In 2 Metre Lengths	Note [3] Brake Rod MONACO KARTS Note [4] 5mm To suit cables



BR202



BR202



BR200

KSI MECHANICAL BRAKES & CABLES



Actuator Lever
BRKS007

Replacement Brake pads



Newfren **BRTL001N1.1** [soft] Newfren **BRTL001N** [hard]



KSI
BRTK001

Caliper Specifications

Dimensions

	Dia.	Centre to Centre
Mount	8mm	80mm
Pad Bolt	6mm	56mm

Parts Part Numbers

Pad Bolt	BRSH021
Spring	BRSH036
Sleeve	BRSH035
Bolt/Spring Kit	BRSH021KIT
Spacer Shin	BRSH026
Bolt Mounting	NBC8100
Cable	BR203
Barrel Cable	BR204
Pivot Ball	BRKS009A



Pivot Actuator Lever
BRKS009A



Barrel Cable End
BR204

BRAKE FITTINGS & PARTS

FITTINGS FOR NYLON PIPE FORMING ITS OWN FLARE



BR068A BR068 BR069B BR069
 STRAIGHT--RIGHT ANGLE-----TEE FITTING 1/8 GAS-----TEE FITTING NYLON

FITTINGS FOR NYLON PIPE USING BRASS OLIVE



BR067 BR067A BR067B BR067C
 STRAIGHT-- RIGHT ANGLE--- TEE FITTING WITH 1/8 GAS---TEE NYLON PIPE
 BRASS OLIVE BRASS PIPE INSERT



BR067D BR067E

BOOTS & FILLER PLUG [MASTER CYLINDER]



UNIVERSAL BOOT
 BRBOOT001BL



UNIVERSAL BOOT
 BRBOOT001BLX



BRDE/MC/BOOT AX8
 DENT BILLET BOOT



UNIVERSAL BOOT
 BRBOOT001



R/R FILLER PLUG
 BRRRK411



EARLY DENT & DINO BOOT
 BRDI025/BOOT

BRAKE PARTS



BRAKE PAD BOLT & RETURN SPRING KIT to suit KSI & CRG BRAKES

SPRING 27.5MM LONG part number
SLEEVE 30.3MM X 6MM **BRSH021KIT**
BOLT 6MM X 35MM

DENT/ARROW



SPRING 27MM X 7.5MM ID
 part number
BRDE027
BOLT 5MM X 35MM
 part number **NBC535**



SLEEVE/BOLT 31MM X 6.5MM
 part number
BRDE022

2 & 4 SPOT CALIPER

To suit DENT/ARROW CAST CALIPERS with 11MM thick pads



SPRING 27MM X 7.5MM ID
 part number
BRDE047
BOLT 5MM X 35MM
 part number **NBC535**



SLEEVE/BOLT 31MM X 6.5MM
 part number
BRDE047A

To suit DENT/ARROW BILLET CALIPERS with 15MM thick pads

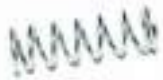

SPRING 27MM X 7.5MM ID
 part number
BRDE047
BOLT 5MM X 40MM
 part number **NBC540**



SLEEVE/BOLT 36MM X 6.5MM
 part number
BRDE047A0

To suit DENT/ARROW BILLET CALIPERS with 15MM thick pads

UNIVERSAL BRAKE PARTS



SPRING
 22mm LENGTH
 KSI

part number
BRSH026



PAD BOLT
 BOLT 6mm X 30mm

part number
BRSH026



SPRING
 18mm LENGTH
 SAME AS SWISS HUTLES , KSI & RIGHETI RIDDOLFI

part number
BRRR029A



BOLT & SPACER KIT
 SLEEVE 8mm DIA 24mm LENGTH
 BOLT 6mm X 30mm
 SAME AS SWISS HUTLES ,
 KSI & RIGHETI RIDDOLFI

part number
BRRR030A

part number
BRRR030/KIT



OTK BS2 BRAKES



SLEEVE
BROT004/CAL/SL



BOLT
NBC530



SPRING
BROT004/CAL/SP

Righetti Ridolfi Rear 4 SPOT Brake Calipers [two piece type]

BRAKE PADS

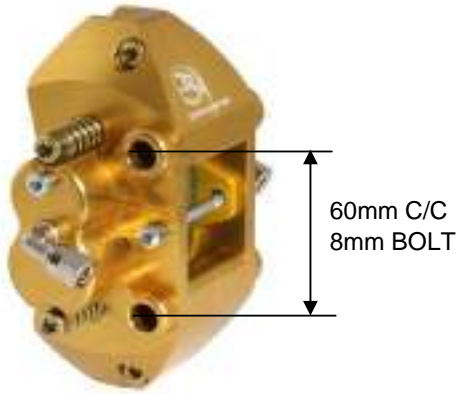

SOFT [RED]
BRRR006A

CNC MACHINED BILLET ALLOY 4 SPOT CALIPERS

CNC TYPE

BLACK BRRRK381CNC4BL

GOLD BRRRK381CNC4BL

SILVER BRRRK381CNC4BL



CAST TYPE

BLACK BRRRK3814BL

GOLD BRRRK3814G



HARD [BLACK]
BRRR006B

NYLON BRAKE LINE FITTINGS



BR067



BR0067B



BR067C

Righetti Ridolfi Rear 4 SPOT Brake Calipers [one piece type]



BRRK381SE4BL



BRRBRACK/AL/RRA
[TO SUIT 18MM WIDE DISC]



BRRK381SE4G

SPEED EVO ONE PIECE CONSTRUCTION BILLET 4 SPOT CALIERS



BRRK381SP4G



[TO SUIT 12MM WIDE DISC]



BRRK381SP4T

BLEEDER NIPPLE

BRRRK875

SPEED EVO ONE PIECE CONSTRUCTION BILLET 4 SPOT CALIERS

REAR BRAKE SYSTEM

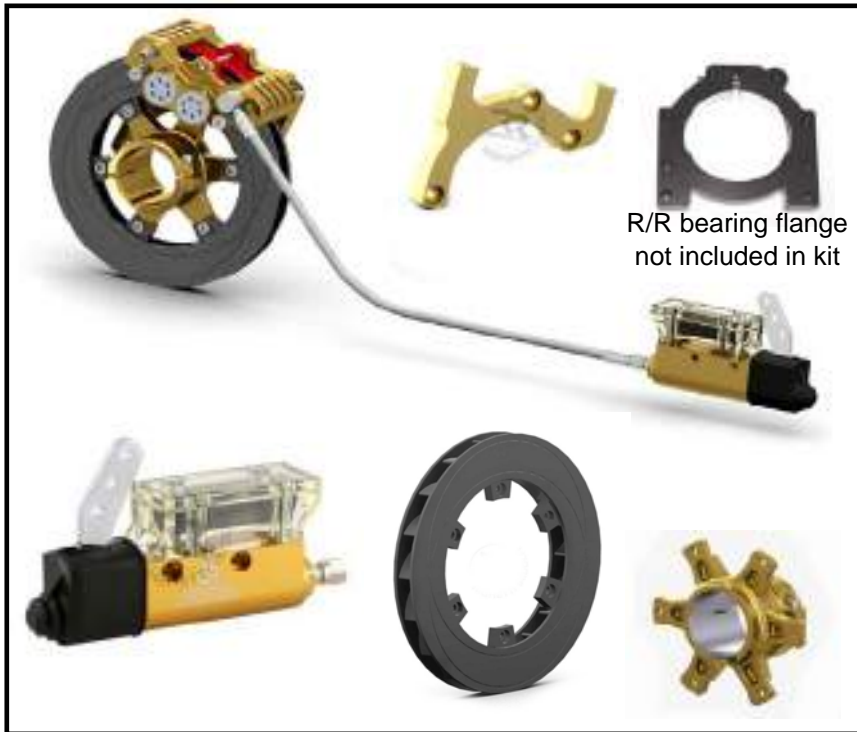

R/R bearing flange
not included in kit

BRAKE PADS



SOFT [RED]
BRRR006A



MEDIUM [YELLOW]
BRRR006C



HARD [BLACK]
BRRR006B

Complete BRAKE SYSTEM INC.

Master Cylinder , 4 Spot Billet Caliper , 18 x 200 Brake Disc and Carrier

This system fits the R/R rear bearing flange

BLACK **BRRRK125BL**

GOLD **BRRRK125G**

FRONT BRAKE SPEED SYS SYSTEM by Righetti Ridolfi



part number **BRRRK123MAG**



25mm SHAFT LH STUB AXLE
KPG/SA/LHRR25FB



BRAKE CALIPER
RH **BRRRK125FCRM**
LH **BRRRK125FCLM**



MASTER CYL, HAND OPERATED
BRRRK125MHM



25mm SHAFT RH STUB AXLE
KPG/SA/RHRR25FB



MAST/CYL FOOT OPERATED
BRRRK225XMAG



DISC & WHEEL HUB ASSY.



M/CYL OPTION
2 X Master Cylinder Plus
Brake Bias assembly



BRAKE DISC LH or RH
BR131CRRF



OTHER COLOUR OPTIONS

BLACK	art number	BRRRK123BL
GOLD	art number	BRRRK123G
MAG	art number	BRRRK123MAG

FRONT BRAKE SPEED EVO SYSTEM by Righetti Ridolfi



BLACK assembly

part number **BRRRK123BLRRWP**



25mm SHAFT LH STUB AXLE
KPG/SA/LHRR25FB



BRAKE CALIPER

RH **BRRRK125FCRBE**
LH **BRRRK125FCLBE**



MASTER CYL, HAND OPERATED
BRRRK125MHB



25mm SHAFT RH STUB AXLE
KPG/SA/RHRR25FB



MAST/CYL FOOT OPERATED
BRRRK225XBLACK



DISC & WHEEL HUB ASSY.



M/CYL OPTION
2 X Master Cylinder Plus
Brake Bias assembly



BRAKE DISC LH or RH
BR127RRFBEVOR
BR127RRFBEVOL



OTHER COLOUR OPTIONS

BLACK part number **BRRRK123KBLRRWP**
GOLD part number **BRRRK123BLRRWPG**
MAG part number **BRRRK123KBLRRWPM**